

# Operating instructions

## DUM Module BASICS

### Flow Monitor



meister 

Series DUM

Type DUM-4 thru DUM-250

Read this manual prior to performing any task!

Meister Strömungstechnik GmbH  
Im Gewerbegebiet 2  
63831 Wiesen  
Germany  
Telephone: +49 6096 9720 - 0  
Fax: +49 6096 9720 - 30  
E-mail: [sales@meister-flow.com](mailto:sales@meister-flow.com)  
Internet: [www.meister-flow.com](http://www.meister-flow.com)

DUM Modul BASICS, 2, en\_US

These instructions were compiled by:  
Meister Strömungstechnik GmbH  
Subject to change without notice

© Meister Strömungstechnik GmbH 2018

These instructions facilitate the safe and efficient handling of a flow monitor (referred to as "device" in the following). The instructions are an integral part of the device and must be kept within easy reach for the personnel in the immediate vicinity of the device at all times. Personnel must carefully read and understand these instructions before commencing all work. The basic requirement for safe work is adherence to all safety and handling instructions stipulated in these instructions. The local accident-prevention regulations and general safety standards and regulations for the field of application of the device also apply. Illustrations in these instructions are provided to aid general understanding and might deviate from the actual model. No claims can be derived from any such differences.

### **Limitations of liability**

All details and instructions in this manual have been compiled under consideration of the valid standards and regulations, the current state-of-technology and our many years of knowledge and experience. The manufacturer does not accept any liability arising from:

- non-observance of any details in these instructions
- improper use of the device, or use that is not in accordance with these instructions
- use of non-trained personnel

- unauthorized retrofitting or technical changes that have not been authorized by the manufacturer
- use of non-approved replacement parts

The duties and obligations agreed upon in the delivery contract apply in full, as well as the general terms and conditions, the terms of delivery by the manufacturer and the valid legal regulations applicable at the conclusion of the contract.

### **Copyright**

These operating instructions are protected by copyright.

Except for internal purposes, transfer of these instructions to third-parties, copying them in any way – even in part – as well as dissemination and/or communication of their content is forbidden without prior written authorization from Meister Strömungstechnik ("manufacturer"). Violations are subject to claims for indemnification. The manufacturer reserves the right to assert additional claims.

Copyright is the property of the manufacturer.

© Meister Strömungstechnik GmbH

Im Gewerbegebiet 2  
63831 Wiesen  
Germany

# Table of contents

<b>1</b>	<b>Overview</b> .....	<b>10</b>
	1.1 Short description.....	10
	1.2 Warranty and guarantee provisions.....	10
	1.3 Customer service.....	10
<b>2</b>	<b>Safety</b> .....	<b>11</b>
	2.1 Explanation of symbols.....	11
	2.2 Correct use in accordance with these instructions.....	13
	2.3 Special precautions.....	14
	2.3.1 Hazards from electrical current.....	15
	2.3.2 Mechanical hazards.....	16
	2.3.3 Hazards from high or low temperatures.....	16
	2.3.4 Radiation hazards.....	17
	2.3.5 Hazards caused by media.....	17
	2.4 Personnel requirements.....	18
	2.5 Personal safety equipment.....	18
	2.6 Protective systems.....	19
	2.7 Replacement parts.....	20
	2.8 Environmental protection.....	20
	2.9 Responsibility of the owner.....	21
<b>3</b>	<b>Design and function</b> .....	<b>23</b>
	3.1 Overview.....	23
	3.2 Device description.....	23
	3.3 Component description .....	24
<b>4</b>	<b>Transport, packaging and storage</b> .....	<b>25</b>
	4.1 Safety instructions for transport.....	25
	4.2 Transport inspection.....	25
	4.3 Packaging.....	25
	4.4 Symbols on the shipping box.....	26
	4.5 Storage.....	26
<b>5</b>	<b>Installation and initial startup</b> .....	<b>28</b>
	5.1 Safety.....	28

5.2	Requirements at the place of installation.....	28
5.3	Preparatory work.....	29
5.4	Installation in the pipe system.....	33
5.5	Initial startup.....	37
5.6	Electrical connection.....	38
5.6.1	Switch contact SG-30 with connector in compliance with EN175301-803.....	39
5.6.2	Switch contact SG-30 with plug connector M12x1.....	40
5.6.3	Switch contact SG-30 with cable.....	41
5.6.4	Degree of protection (IP-Code).....	42
5.7	Grounding the device.....	42
5.8	Plug connection.....	43
5.9	Contact protection measures.....	45
<b>6</b>	<b>Operation.....</b>	<b>47</b>
6.1	Setting the switch point.....	47
6.2	Checking the flow.....	49
<b>7</b>	<b>Troubleshooting.....</b>	<b>50</b>
7.1	Safety.....	50
7.2	Troubleshooting guide.....	52
<b>8</b>	<b>Maintenance.....</b>	<b>54</b>
8.1	Safety.....	54
8.2	Maintenance plan .....	54
8.3	Removal from the pipe system.....	55
8.4	Disassembly.....	57
8.5	Maintenance .....	61
8.5.1	Cleaning.....	61
8.5.2	Parts replacement .....	62
8.5.3	Assembly.....	62
8.5.4	Switch contact replacement .....	67
8.6	Measures to be taken after maintenance work.....	70
<b>9</b>	<b>Disassembly and disposal.....</b>	<b>71</b>
9.1	Safety.....	71
9.2	Disassembly.....	71

9.3	Return Materials.....	71
9.3.1	Return Materials Authorization.....	71
9.4	Disposal.....	72
<b>10</b>	<b>Technical data.....</b>	<b>73</b>
10.1	Device data plate.....	73
10.2	Switch contact data plate.....	73
10.2.1	Switch contact data plate for UL Recognized switch contacts.....	73
10.3	Dimension sheet.....	74
10.4	General specifications.....	77
10.5	Electrical specifications.....	80
10.5.1	Electrical specifications for UL Recognized devices.....	82
10.6	Measuring ranges.....	82
10.6.1	Standard measuring ranges.....	82
10.7	Operating data.....	83
<b>11</b>	<b>Annex.....</b>	<b>86</b>
11.1	Tightening torque.....	86
11.2	Replacement parts list.....	86
11.3	Tools.....	92
11.4	Sealant.....	92
11.5	Lubricants.....	93
<b>12</b>	<b>Index.....</b>	<b>94</b>

## List of figures

Fig. 1:	DUM flow monitor.....	10	Fig. 20:	Switch position under no-flow condition.....	41
Fig. 2:	Front view.....	23	Fig. 21:	Switch position under no-flow condition.....	42
Fig. 3:	Switch contact and female socket.....	24	Fig. 22:	Detach socket.....	43
Fig. 4:	DUM switch point adjustment scale .....	24	Fig. 23:	Remove socket.....	43
Fig. 5:	Installation position/direction of flow.....	29	Fig. 24:	Loosen inner section.....	43
Fig. 6:	Unimpeded flow sections.....	31	Fig. 25:	Loosen the screw connection.....	44
Fig. 7:	Unimpeded outlet.....	31	Fig. 26:	Pin assignment, plug socket, normally-open contact (SG-30 with connector in compliance with EN175301-803).....	44
Fig. 8:	Strainer.....	32	Fig. 27:	Pin assignment, plug socket, change-over contact (SG-30 with connector in compliance with EN175301-803).....	45
Fig. 9:	Apply sealing thread.....	35	Fig. 28:	Example 1.....	45
Fig. 10:	Pipe connection with sealing thread.....	35	Fig. 29:	Example 2.....	45
Fig. 11:	Screw in the device.....	36	Fig. 30:	Protective measure against capacitive loads..	46
Fig. 12:	Screw in the device.....	36	Fig. 31:	Example 1.....	46
Fig. 13:	Switch position under no-flow condition.....	39	Fig. 32:	Example 2.....	46
Fig. 14:	Pin assignment, plug socket, normally-open contact. The ground-pin is not used.....	39	Fig. 33:	Loosen set screws.....	47
Fig. 15:	Switch position under no-flow condition.....	39	Fig. 34:	Loosen the set screws....	48
Fig. 16:	Pin assignment, plug socket, change-over contact. The ground-pin is not used.....	39	Fig. 35:	Reading-off the switch point (example).....	49
Fig. 17:	Pin-assignment, socket M12x1 (Form 30x70).....	40	Fig. 36:	Loosen process connection (outlet).....	58
Fig. 18:	Switch position under no-flow condition.....	40	Fig. 37:	Remove the process connection (outlet).....	59
Fig. 19:	Switch position under no-flow condition.....	40	Fig. 38:	Remove the centering disc (outlet).....	59
			Fig. 39:	Remove inner parts.....	59

Fig. 40: Inner parts DUM.....	60	Fig. 62: Adhesive label, switch contact with positioning arrow .....	73
Fig. 41: Loosen process connection (inlet).....	60	Fig. 63: Type DUM-55.....	74
Fig. 42: Remove the process connection (inlet).....	61	Fig. 64: Type DUM-90.....	75
Fig. 43: O-ring (seal).....	63	Fig. 65: Type DUM-220 ATEX and DUM-250.....	76
Fig. 44: Properly positioned O-ring.....	63	Fig. 66: Type DUM-55.....	87
Fig. 45: Insert process connection (inlet).....	64	Fig. 67: Type DUM-90.....	89
Fig. 46: Tighten process connection (inlet).....	64	Fig. 68: Type DUM-220 and DUM-250.....	91
Fig. 47: Inner parts.....	65		
Fig. 48: Insert inner parts.....	65		
Fig. 49: insert centering disc (outlet) .....	65		
Fig. 50: Insert process connection (outlet).....	66		
Fig. 51: Tighten process connection (outlet).....	66		
Fig. 52: Check for smooth operation.....	67		
Fig. 53: Loosen female socket....	67		
Fig. 54: Remove female socket....	67		
Fig. 55: Loosen set screws.....	68		
Fig. 56: Remove the switch contact from guide rails.....	68		
Fig. 57: Remove switch contact...	69		
Fig. 58: Device data plate.....	73		
Fig. 59: Switch contact rating plate.....	73		
Fig. 60: Switch contact rating plate with positioning arrow .....	73		
Fig. 61: Switch contact data plate.....	73		



## List of tables

Table 1: Correct use in non-hazard areas.....	13
Table 2: Correct use of UL Recognized Components in non-hazard areas.....	13

# 1 Overview

## 1.1 Short description

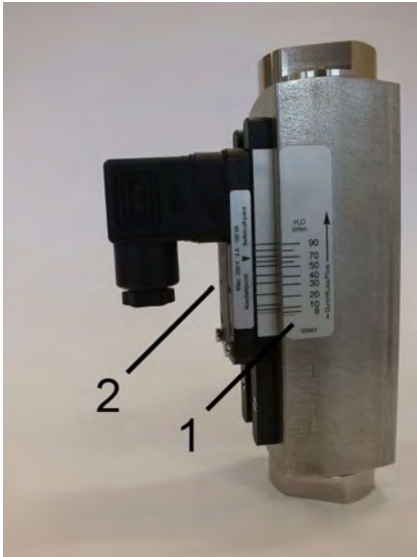

Fig. 1: DUM flow monitor

- 1 Switch point adjustment scale
- 2 Switch contact with female socket or connection cable

The flow monitor DUM monitors the continuous flow of liquids. It is designed for installation in pipe systems.

A float inside the device is moved by the medium flowing through it. The desired switch point can be set on the switch point adjustment scale, whereby the arrow on the switch contact is aligned to the desired flow value on the switch point adjustment scale.

External measuring devices can be connected at the socket.

## 1.2 Warranty and guarantee provisions

Warranty and guarantee provisions are contained in the general terms and conditions of Meister Strömungstechnik.

## 1.3 Customer service

For technical support, please contact our customer service department (for contact details, see Page 2).

Furthermore, our staff is always interested in receiving new information and experiences gained from application of the device, which may be useful in improving our products.

## 2 Safety

This chapter provides an overview of important safety aspects required for optimum protection of personnel as well as for safe installation and safe operation of the device.

Non-observance of the handling and safety instructions listed in this manual may result in hazardous/dangerous conditions and in damage to property.

### 2.1 Explanation of symbols

#### Safety instructions

Safety instructions in this manual are marked by symbols. The safety instructions are preceded by signal words that indicate the level of danger/hazard.

To prevent accidents or injury to persons as well as damage to property, always observe the safety instructions and proceed carefully.



#### **DANGER!**

This combination of symbol and signal word indicates an immediate, dangerous condition that results in death or serious injury if it is not avoided.



#### **WARNING!**

This combination of symbol and signal word indicates a possibly dangerous condition that might result in death or serious injury if it is not avoided.



**CAUTION!**

This combination of symbol and signal word indicates a possibly dangerous condition that might result in minor or slight injury if it is not avoided.



**NOTICE!**

This combination of symbol and signal word indicates a possibly dangerous condition that might result in damage to property and to the environment if it is not avoided.

- ➔ Designates step-by-step handling instructions
  - ⇒ Designates a state or an automatic sequence as a result of a specific operating step
  
- Designates randomly ordered enumerations and list entries
  - ↪ “Signs used in these instructions” on page 12, designates references to chapters in these instructions

**Tips and recommendations**



*This symbol emphasizes useful tips and recommendations as well as information for efficient and failure-free operation.*

**Signs used in these instructions**

The following signs and highlightings are used in these instructions to identify handling instructions, the description of results, lists/enumerations, references and other elements:

## 2.2 Correct use in accordance with these instructions

The device is designed and constructed exclusively for the intended use described herein.

*Table 1: Correct use in non-hazard areas*

The flow monitor serves exclusively to monitor the continuous flow of liquids within a temperature range of -20 °C to 100 °C (optional: 160 °C) at a maximum operating pressure: see chapter 10.7 Operating data ( ↪ *Chapter 10.7 "Operating data" on page 83*).

*Table 2: Correct use of UL Recognized Components in non-hazard areas*

The flow monitor serves exclusively to monitor the continuous flow of liquids within a temperature range of -15 °C to 100 °C at a maximum operating pressure: see chapter 10.7 Operating data ( ↪ *Chapter 10.7 "Operating data" on page 83*).

### Correct use in explosion-hazard zones

For employment in explosion-hazard zones, changed conditions apply for the intended use.

The intended use in explosion-hazard zones is described in the Operating Instructions "DUM Module ATEX".

Intended use in explosion-hazard zones includes the observance of all specifications in these Operating Instructions, as well as those for "DUM Module ATEX".

Any additional or different application, above and beyond the correct use in accordance with these instructions, is deemed as incorrect use.



### WARNING!

#### Danger due to incorrect use!

Incorrect use of the flow monitor may result in dangerous conditions

- Use the flow monitor only within the stipulated performance limits
- Do not subject the flow monitor to severe temperature fluctuations
- Do not use the flow monitor with quick-acting valves
- Do not use the flow monitor with solenoid valves
- Do not subject the flow monitor to vibrations
- Do not subject the flow monitor to pressure surges
- Do not use the flow monitor with media containing solids or abrasives
- Use the flow monitor only with media previously approved by the manufacturer

- Do not use the flow monitor as the sole monitoring device to prevent dangerous conditions
- Do not install the flow monitor as a supporting part within a pipeline system
- The flow monitor with sight glass must be installed in such a way as to preclude damage to the sight glass by outside force. If necessary, install an appropriate impact protection device



*These Operating Instructions cannot cover all conceivable dangers because many dangers arise, not from the device itself, but from the respective media flowing through it. Always observe the appropriate safety data sheets when using hazardous media!*

All claims for damages due to incorrect use are excluded.

## 2.3 Special precautions

The following section lists residual risks that might arise from the device.

To reduce health risks and prevent dangerous conditions, observe the safety instructions listed here as well as the safety instruction in the other chapters of these Operating Instructions.



### **DANGER!**

**Employment of the device in explosion-hazard zones requires the observance of the Operating Instructions for "DUM Module ATEX" including all hazard statements and warnings, therein.**

## 2.3.1 Hazards from electrical current

### Electrical current



#### **DANGER!**

#### **Danger to life from electrical current!**

There is an immediate risk to life from electrocution on touching live parts. Damaged electrical insulation or components can be extremely dangerous.

- Only qualified electricians shall work on the electrical system.
- If the insulation is damaged, immediately switch off and have repairs performed.
- Before commencing work on live parts of the electrical systems and operating equipment, disconnect the equipment and ensure that it remains disconnected for the duration of the work. Observe these 5 safety rules when doing so:
  - Isolate (disconnect)
  - Secure against switching back on
  - Check for absence of voltage
  - Ground and short
- Cover or cordon off other live parts in the vicinity
- Never bridge fuses or put them out of operation. Always observe the correct current ratings when replacing fuses
- Keep moisture away from live parts. This can result in short-circuit

## 2.3.2 Mechanical hazards

### WARNING!

#### **Risk of injury due to fractured housing and leakage!**

Unauthorized temperatures or excessive pressure may cause the flow monitor body or the process connections to burst. Injury may be caused by flying debris and escaping media.

- Keep within the stipulated operating limits
- Wear personal protective equipment
- Avoid severe temperature fluctuations
- Avoid pressure surges

### WARNING!

#### **Risk of injury on sharp edges and pointed corners!**

Sharp edges and pointed corners can cause abrasions and skin cuts.

- Proceed with caution when working near sharp edges and pointed corners
- If in doubt, wear protective gloves

## 2.3.3 Hazards from high or low temperatures

### Hot or cold surfaces

### WARNING!

#### **Risk of injury from hot or cold surfaces!**

Surfaces of components may heat up/cool down dramatically due to the media flowing through them. Skin contact with hot or cold surfaces may cause severe skin burn or frostbite.

- Always wear temperature-resistant protective work clothing and protective gloves when working near hot/cold surfaces
- Before commencing work, make sure that all surfaces have been cooled down or warmed up to ambient temperature



## 2.3.4 Radiation hazards

### Strong magnetic fields



**WARNING!**

**Danger to life from strong magnetic fields!**

Strong magnetic fields may cause severe injury or even be fatal, as well as cause considerable damage to property.

- Persons with pacemakers must not be located in the vicinity of the device. This could impair the function of the pacemaker
- Persons with metal implants must not be located in the vicinity of the device. Implants can heat up or be attracted magnetically
- Keep ferromagnetic materials and electromagnets away from the magnetic source. These materials could be attracted and fly through the room, thereby injuring or even killing persons. Minimum clearance: 3 m
- Remove and put away metal objects before maintenance work (jewelry, watches, writing implements, etc.)

- Do not place any electronic devices within the vicinity of the magnetic source. These could be damaged
- Do not place any electronic storage media, credit cards, etc. within the vicinity of the magnetic source. Data could be deleted

## 2.3.5 Hazards caused by media

### Hazardous media



**WARNING!**

**Risk of injury from hazardous media!**

If the flow monitor is used for toxic, corrosive or very hot/cold media, there is a risk of serious injury from escaping media.

- Observe details in the safety data sheet of the media
- Comply with the safety, accident prevention and environmental protection regulations appropriate to the media used
- Wear personal protective equipment in accordance with the safety data sheet

## 2.4 Personnel requirements



### WARNING!

#### **Risk of injury due to insufficiently trained and qualified personnel!**

If unqualified personnel work on the device or are located within its hazard zone, dangers arise which may result in serious injury and considerable damage to property.

- All work must be performed by qualified personnel only.
- Keep unqualified personnel away from hazard zones.

Authorized personnel is to be restricted to those persons who can be expected to perform their work reliably. Persons whose ability to respond is influenced, e.g. by drugs, alcohol or medication, are not authorized.

Observe the age and occupational regulations at the site when choosing personnel.

The following lists the personnel qualifications for the various areas of activity:

### **Qualified electrician**

Due to specialized training, knowledge and experience as well as knowledge of the relevant standards and regulations, the qualified electrician is able to independently perform work on the electrical systems as well as to detect and avoid possible risks and dangers.

Additionally, the electrician must provide proof of his/her professional qualification that certifies his/her ability to perform work on electrical systems.

The qualified electrician must fulfill the requirements contained in the valid legal accident-prevention regulations.

### **Qualified personnel**

Due to their specialized training, knowledge and experience as well as their knowledge of the relevant standards and regulations, qualified personnel are able to independently perform the work assigned to them as well as to detect and avoid possible risks and dangers.

## 2.5 Personal safety equipment

Personal safety equipment is used to protect personnel from hazards or dangers that might impair their safety or health during work.

When performing the various tasks at, and with the device, personnel must wear personal safety equipment. Special reference is made of this in the individual chapters within these Operating Instructions. The following provides a description of the personal safety equipment:

- Always wear appropriate personal safety equipment required in the various chapters of these Operating Instructions before commencing work.
- Comply with the personal safety equipment instructions posted within the work area.

### Description of personal safety equipment

**As specified in the Safety Data Sheet of the medium, protective equipment must be worn when handling hazardous media. In addition, the specifications of the system operator must be followed. If no protective equipment is specified, suitable protective gloves and goggles must be worn.**

The protective equipment is used to protect against hazardous media leaks and hazardous media residue in the device.

### Goggles



The goggles are used to protect the eyes from flying debris and splashing fluid.

### Protective gloves



Protective gloves protect the hands from friction, burns, grazing, abrasion, surface cuts or deeper injuries, as well as from direct contact with hot or cold surfaces.

## 2.6 Protective systems

### Integration within an emergency-stop concept is required

The device is designed for use as a part of a machine or system. It does not have its own controller and does not have an autonomous emergency-stop function.

Before starting up the device, install the emergency-stop equipment and incorporate it into the safety chain of the machine or system.

Connect the emergency-stop equipment so that if there is an interruption in the power supply or in the activation of the power supply after an interruption, dangerous conditions are excluded for persons and valuables.

The emergency-stop equipment must always be freely accessible.

## 2.7 Replacement parts



### WARNING!

#### **Risk of injury due to use of incorrect replacement parts!**

Use of incorrect or faulty replacement parts may result in dangers to personnel as well as damages, malfunctions or total failure.

- Only use original replacement parts from the manufacturer or approved by the manufacturer.
- Always contact the manufacturer in case of doubt.

Always purchase replacement parts from an authorized dealer or directly from the manufacturer (For contact details, see Page 2).

The replacement parts list is in the annex.

## 2.8 Environmental protection



### NOTICE!

#### **Risk to the environment due to improper handling of environmentally hazardous substances!**

Serious environmental damage may result if substances harmful to the environment are handled incorrectly, especially if they are disposed of improperly.

- Always observe the instructions listed below on the handling and disposal of substances harmful to the environment.
- If harmful substances are released into the environment, take immediate countermeasures. If there is doubt, contact the local authorities, inform them of the damage and request information on suitable countermeasures to be taken.

### Cleaning fluids

Solvent-based cleaning fluids contain toxic substances. They must never be released into the environment and must be disposed of by a waste management company.

## Lubricants

Lubricants such as greases and oils contain toxic substances. They must never be released into the environment and must be disposed of by a waste management company.

## 2.9 Responsibility of the owner

### Owner

The owner is the person who operates the device himself for business or commercial purposes or who cedes such use/application to a third-party and who, during operation of the device, has full legal product stewardship for protection of the user, the personnel or third-parties.

### Duties of the owner

The device is used in the commercial sector. The owner of the device is therefore subject to legal obligations pertaining to work safety.

In addition to the safety instructions contained in these Operating Instructions, the safety, accident prevention and environmental protection regulations applicable to the field of application of the device must be observed.

In particular, this includes:

- The owner must inform himself regarding the valid health and safety regulations and must perform a risk assessment to additionally determine the risks resulting from the special work

conditions arising at the location at which the device is used, especially in regard to the media used. He must then implement these within Operating Instructions for use of the device.

- **For the USA:**

The "Occupational Health and Safety Act" of 1970 stipulates that it is the duty of the owner to provide a safe workplace. He must hereby ensure that the device is operated and maintained compliant to valid commercial, industrial, local, federal and state laws, standards and regulations.

- **For Canada:**

The "Canadian Centre for Occupational Health and Safety Act" of 1978 stipulates that all Canadians have "...a fundamental right to a healthy and safe working environment." It is therefore the duty of the owner to provide a safe workplace. He must ensure that the device is operated and maintained compliant to valid commercial, industrial, local, provincial, territorial and federal laws, standards and regulations.

- Appropriate to the working conditions and the media used, the owner must affix signs within the working area that inform the user of the hazards and dangers present.

- During the entire period of use of the device, the owner must check periodically to ensure that the Operating Instructions correspond to the current state of regulations, and he must make adjustments as necessary.
- The owner must clearly regulate and determine responsibilities for installation, operation, trouble-shooting, maintenance and cleaning.
- The owner must fit/retrofit suitable safety equipment within the complete plant/system.
- The owner must ensure that all staff/personnel have thoroughly read and understand these instructions before handling the device. Additionally, he must train the personnel at regular intervals and warn them of dangers.
- The owner must provide the personnel with the required safety equipment and must instruct them that its wear is mandatory.
- The owner must ensure that the maintenance intervals described in these Operating Instructions are adhered to at all times.
- The owner must ensure that the device is completely free of all residual media before disposal. Remains of corrosive or toxic materials must be neutralized.

Additionally, the owner is responsible for ensuring that the device is always kept in a technically perfect condition. The following therefore applies:

- The owner must implement suitable safety measures, appropriate to the media used.
- Different media have different severities of influence on the soiling and wear of/to the device. The owner must set suitable maintenance intervals, depending on the media flowing through the device.

### 3 Design and function

#### 3.1 Overview

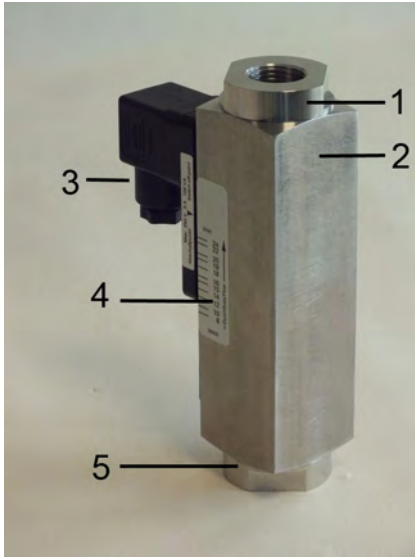

Fig. 2: Front view

- 1 Process connection (outlet)
- 2 Device body
- 3 Switch contact and female socket or switch contact with cable
- 4 Switch point adjustment scale
- 5 Process connection (inlet)

A float inside the flow monitor is moved by the flowing medium. A magnetic field is generated by the magnets inside the float. The position of the float is detected by a switch contact. The desired switch point can be set on the scale on the device body by moving the switch contact.

Applications for DUM flow monitors are, for example, cooling circuits. The device monitors the volume flow of the cooling media to ensure sufficient cooling. If the flow drops below the threshold set by the operator, the switch contact switches (Change-over Contact) or opens the contact (Normally Open Contact).

#### 3.2 Device description

DUM flow monitors work according to the functional principle of the variable area flow meter. The flow monitor is installed into a pipe system and measures the flow rate of the medium flowing through the pipe system.

### 3.3 Component description

#### Switch contact

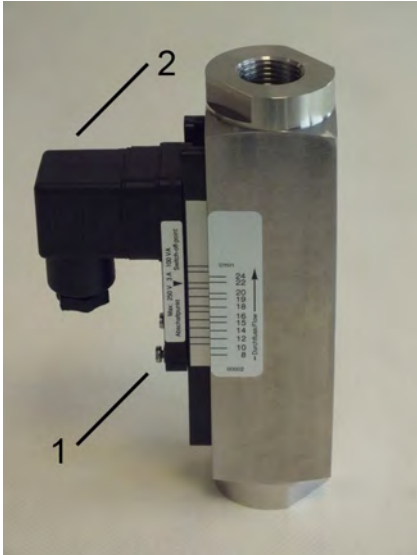

Fig. 3: Switch contact and female socket

A potential-free Reed contact is cast into the switch contact (Fig. 3/1). The device is supplied with a connector (Fig. 3/2).

#### Switch point adjustment scale



Fig. 4: DUM switch point adjustment scale

A scale is applied to the device body, to which the desired switch point can be adjusted.



## 4 Transport, packaging and storage

### 4.1 Safety instructions for transport

#### Improper transport

#### **!** NOTICE!

**The device could be damaged if transported improperly!**

Objects to be transported may fall or overturn if transported improperly. This may result in damage to the device and/or property.

- Proceed carefully when unloading transported packages, both on delivery and when transporting in-house. Observe the symbols and instructions on the shipping box
- Remove packaging material just prior to assembly

### 4.2 Transport inspection

On delivery, make an immediate check for completeness and check for transport damages.

If there are any visible external transport damages, proceed as follows:

- Do not accept the delivery
- Note the damage in the shipping documents or on the delivery note of the transporter and have the driver confirm by signature
- Initiate a claim for damages



*Make a claim for each fault as soon as it is detected. Claims for damages can only be invoked within the valid claim periods.*

### 4.3 Packaging

#### Packaging

The packaging serves to protect the individual components from transport damages, corrosion and other damages until they are installed. Do not discard the packaging and only remove the device from the shipping box immediately before installation.

### Handling packaging materials

Dispose of packaging material in accordance with the valid legal regulations and local ordinances.

**! NOTICE!**

**Danger to the environment due to incorrect disposal!**

Packaging is made of valuable raw materials and can be reused in many cases or usefully processed and recycled. Improper disposal of packaging materials may pose a danger to the environment.

- Dispose of packaging material in an environmentally safe manner
- Comply with the local disposal regulations. If necessary, have the packaging disposed of by approved specialists.

## 4.4 Symbols on the shipping box

### Top



The arrows indicate the top side of the package. They must always point upwards, otherwise the content may be damaged.

### Fragile



Designates packages with breakable or damageable contents.

Handle the package carefully and do not allow it to fall or be subjected to jarring or severe vibration.

## 4.5 Storage

### Storing the packages

Store the packages under the following conditions:

- Do not store in the open
- Store dry and dust-free
- Do not subject to any aggressive media
- Protect from direct sunlight
- Avoid mechanical vibrations and shocks
- Storage temperature: 0 to 35 °C / 32 °F to 95 °F
- Relative humidity: max. 60 %
- Do not stack
- If storing for longer than 3 months, regularly check the general condition of all parts as well as of the packaging.



*Storage instructions in addition to the instructions listed here may be listed on the packages. Follow these instructions also.*

## 5 Installation and initial startup

### 5.1 Safety

#### Incorrect installation and initial startup

##### **WARNING!**

##### **Risk of injury due to incorrect installation and initial startup!**

Incorrect installation and initial startup may result in severe injury and considerable damage to property.

- Ensure that the site is sufficiently cleared of obstructions before commencing work
- Handle open or sharp edged components carefully
- Ensure that the assembly location is orderly and clean! Parts and tools lying about or on top of each other are potential causes for accidents
- Assemble components properly. Observe the stipulated tightening torque of screws
- Before initial startup, make sure that all installation work has been performed and completed in compliance with the specifications and instructions in these Operating Instructions

#### Safeguard against restart

##### **WARNING!**

##### **Danger to life due to unauthorized restart!**

There is a risk of severe or even fatal injury due to unauthorized restart of the power supply during installation.

- Before commencing work, switch off the power supply to the entire system/plant and secure against restart

### 5.2 Requirements at the place of installation

#### The place of installation must meet the following requirements:

- The device must not be under water.
- The surrounding area must be sufficiently illuminated.
- There must be sufficient space to prevent accumulation of trapped heat.
- The device must not be installed as a supporting part in a pipe construction.
- The device may not have anything affixed to, or suspended from it.

- The flow monitor must be installed in such a way as to preclude damage by outside force. It must be ensured that the flow monitor cannot be damaged. If necessary, install an appropriate impact protection device.
- External magnetic fields will influence the switch contact. Keep sufficient distance to magnetic fields (e.g. electric motors).
- Piping, process connections or supports made of ferromagnetic material influence the magnetic field of the device. Keep a space of at least 100 mm to those materials (e.g. steel).

 **WARNING!**

**Danger due to incorrect installation!**

If the requirements listed above are not met when installing the flow monitor, dangerous/hazardous conditions may arise.

- Do not install the flow monitor as a supporting part in a pipe system
- Do not use the flow monitor with quick-acting valves
- Do not use the flow monitor with solenoid valves

**Requirements for the environmental conditions when using UL Recognized Components :**

- indoor use
- altitude up to 2000 m
- temperature -15°C to 100°C
- max. relative humidity 80 % for temperatures up to 31 °C decreasing linearly to 50 % relative humidity at 40 °C
- mains supply voltage fluctuations up to +/-10 % voltage
- overvoltage category II
- pollution degree 2

**5.3 Preparatory work**

The following requirements must be met during installation to ensure correct functioning of the flow monitor:

**Installation position/direction of flow**

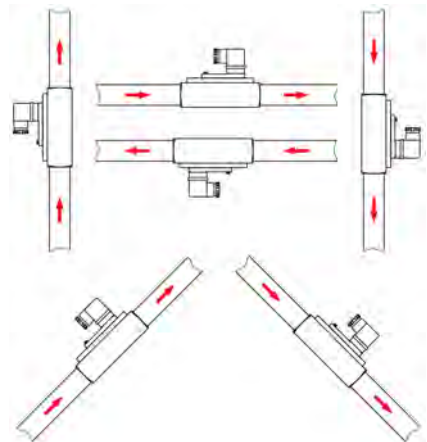

*Fig. 5: Installation position/direction of flow*

Install the flow monitor only in one of the positions displayed in the drawing. The medium must flow in the direction of the arrow (from a low to a high scale value).

### Unimpeded flow sections

#### **! NOTICE!**

#### **Measuring inaccuracy due to incorrect installation!**

The measuring accuracy of the flow monitor is influenced by its position within the pipe system. Changes in cross-section, branch-offs or bends in the pipe system impair measuring accuracy.

- Ensure that the unimpeded flow sections are maintained
- Never reduce the pipe diameter immediately before the device



*We recommend Type BS-228 unimpeded flow sections.*

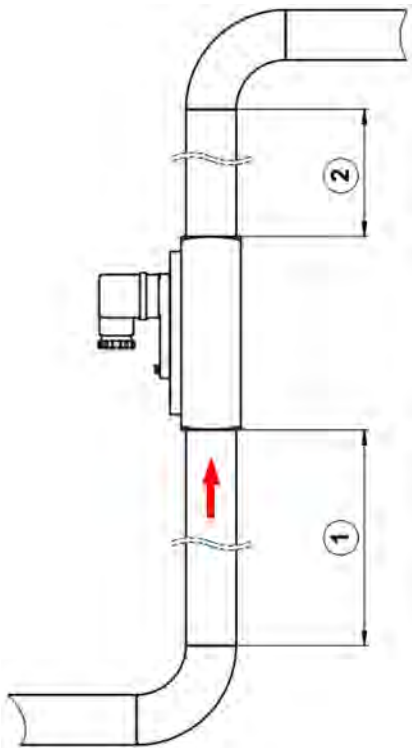

Fig. 6: Unimpeded flow sections

- 1 10x DN
- 2 5x DN

- An unimpeded flow section of 10xDN (rated width) must be maintained before the device.
- An unimpeded flow section of 5xDN (rated width) must be maintained after the device.

### Unimpeded outlet

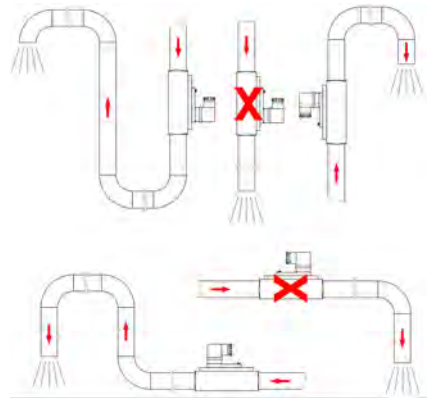

Fig. 7: Unimpeded outlet

If the pipe system ends at an unimpeded outlet, the flow monitor must not be installed directly in front of the opening. The device must always be completely filled with media to ensure measuring accuracy.

**Strainer**

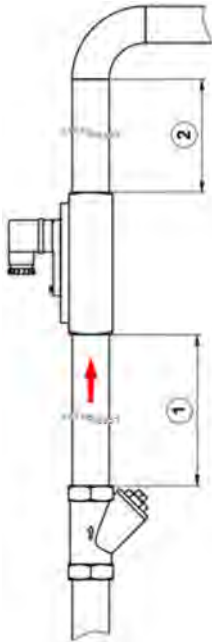



Fig. 8: Strainer

- 1 min. 10x DN
- 2 min. 5x DN

If the medium is contaminated by solids, a strainer must be installed before the device (  "Strainer" on page 32).



We recommend a Type SF, SFD or SFM strainer.

**Prepare the device**

**! NOTICE!**



**Risk of damage to property due to contamination!**

Contamination and deposits may impair the free movement of the float, thereby damaging the device.

- Ensure that there are no foreign particles in the device
- Ensure that the device is not soiled
- Do not use any medium containing solids



Due to quality assurance measures, there may be some test medium (oil) residue in the device.

1.  Unpack the device and visually inspect the device to ensure that it is free of packaging materials
2.  Examine the device for residue of test medium and drain, if necessary
3.  Check the device for soiling and flush with clean medium, if necessary



## 5.4 Installation in the pipe system



### WARNING!

#### Risk of injury from pressurized pipes!

If the pipe system is under pressure when installing the device, severe injury may result.

- Depressurize the pipe system before installing the device



### WARNING!

#### Risk of injury from hot or cold surfaces!

Pipelines can heat up/cool down dramatically due to the media flowing through them. Skin contact with hot or cold surfaces may cause severe skin burn or frost bite.

- Before commencing work, ensure that the system has been controlled to a temperature range between 0 and 40 °C.
- Do not touch any parts of the system that are either very hot or very cold.
- Always wear heat-resistant/cold-resistant protective clothing and protective gloves when working near hot/cold surfaces.



### **WARNING!**

#### **Risk of injury from media in the pipe system!**

If the pipe system contains hazardous media, severe injury may be caused by escaping media.

- Before installation, ensure that the pipe system is empty and does not contain any media residue
- Always wear personal protective equipment during installation
- Provide suitable draining devices (drip pans, collection tanks, etc.)



*A suitable sealant must be selected depending on the condition/composition of the pipe lines, the medium and the operating and environmental conditions. The sealing method described here is only an example and cannot be used in all cases.*



### **NOTICE!**

#### **Risk of damage to the device due to contamination in the pipe system!**

Dirt and foreign particles entering the device can damage the device and impair its operation.

- Ensure that the pipe system is clean before installing the device
- If necessary, flush the pipe system with clean medium before installation

## Sealing the pipe connections

### Personnel:

- Qualified personnel

#### 1. Nap the thread.

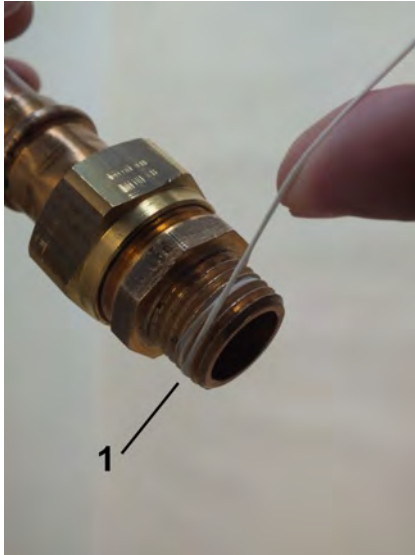

*Fig. 9: Apply sealing thread*

- #### 2. Apply sealing thread (Fig. 9/1) to the napped thread in the threaded direction. Observe the quantity recommended by the sealant manufacturer.



*Fig. 10: Pipe connection with sealing thread*

- ⇒ The pipe line is now ready for installation (Fig. 10)

## Install device in pipe system

### Personnel:

- Qualified personnel

### Protective equipment:

- Protective gloves

### Tools:

- Fixed spanner

### CAUTION!

Do not hold the device by its threads. These are sharp edged and may cause injury.

1. Start the threaded end of the device onto the thread of the connecting pipe.

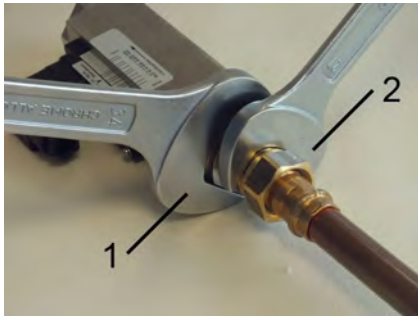

Fig. 11: Screw in the device

2. Fasten the adapter union of the pipeline with an appropriate spanner (Fig. 11/2). When doing so, lock the process connector in place to prevent slip, using a suitable spanner. (Fig. 11/1)

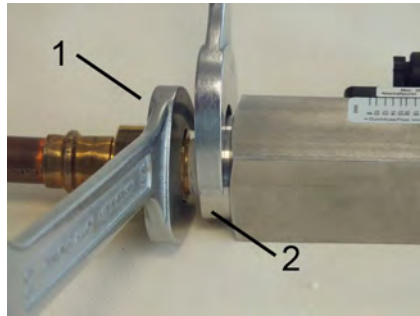

Fig. 12: Screw in the device

3. Keep turning in the adapter union (Fig. 12/1) while holding the process connection of the device locked (Fig. 12/2) until the connection is tight.
4. Repeat these steps at the other end of the device.

## 5.5 Initial startup

The following steps must be taken before initial startup and any subsequent startup (e.g. after removal and installation during maintenance).

1. 



### WARNING!

Ensure that the plant is operating vibration-free. Vibrations could destroy the device. This may result in serious injury to the user.

2. 



### WARNING!

Ensure that the medium is flowing continuously. Pulse-like staggered loads could destroy the device. This may result in serious injury to the user.

3. 



### NOTICE!

Completely fill the pipelines. Partial filling(s) may result in malfunctions and damage to the device.

4. 



### NOTICE!

Vent the pipeline. If there are air pockets in the line during the measurement, this could result in damage to the device caused by hydraulic shock. This may cause malfunctions.

5. 



### NOTICE!

Ensure that the plant is operating without cavitation. Cavitation may result in malfunctions and damage to the device.

## 5.6 Electrical connection

The electrical connection of the flow monitor is accomplished through the connector plug or the cast on power cable leading from the switch housing. For UL Recognized switch contacts SG-30, with connector in compliance with EN 175301-803, the connection cable must be rated min. 105 °C.

The switch contacts employed in these devices are potential free and do not require a power source. Switch contacts and flow monitor have been optimally harmonized. After replacement of a switch contact, the switch point must be readjusted.



### **DANGER!**

#### **Danger to life from electrical current**

There is an immediate risk to life from electrocution on touching live parts. Damage to the electrical insulation or single components can be extremely dangerous.

- Only qualified electricians shall work on the electrical system
- If the insulation is damaged, immediately switch off and have repairs performed

- Before commencing work on live parts of electrical systems and components, disconnect the equipment and ensure that it remains disconnected for the duration of the work. Observe these 5 safety rules when doing so:
  - Isolate (disconnect)
  - Secure against switching back on
  - Check for absence of voltage
  - Ground and short
  - Cover or cordon off other live parts in the vicinity
- Never bridge fuses or put them out of operation. Always observe the correct current ratings when replacing fuses
- Keep moisture away from live parts. This may result in short-circuit

### 5.6.1 Switch contact SG-30 with connector in compliance with EN175301-803

Wiring diagram of the supplied socket (EN 175301-803, Form A) front view.

Wiring diagram

Normally Open (NOC):

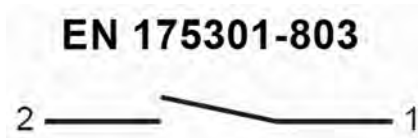

Fig. 13: Switch position under no-flow condition

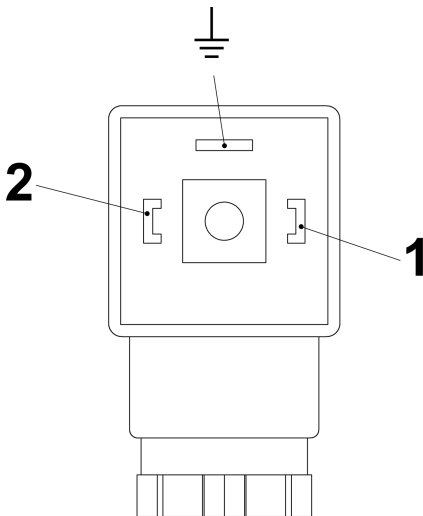

Fig. 14: Pin assignment, plug socket, normally-open contact. The ground-pin is not used.

Change Over (COC):

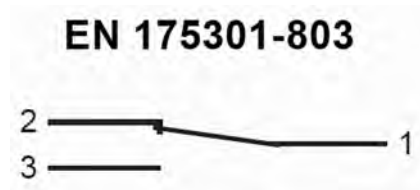

Fig. 15: Switch position under no-flow condition

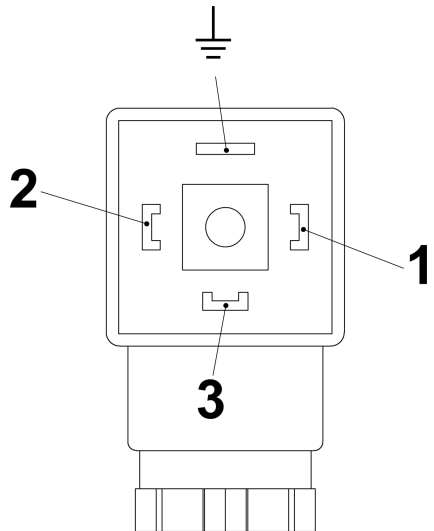

Fig. 16: Pin assignment, plug socket, change-over contact. The ground-pin is not used.

### 5.6.2 Switch contact SG-30 with plug connector M12x1

Wiring diagram, socket (M12x1)

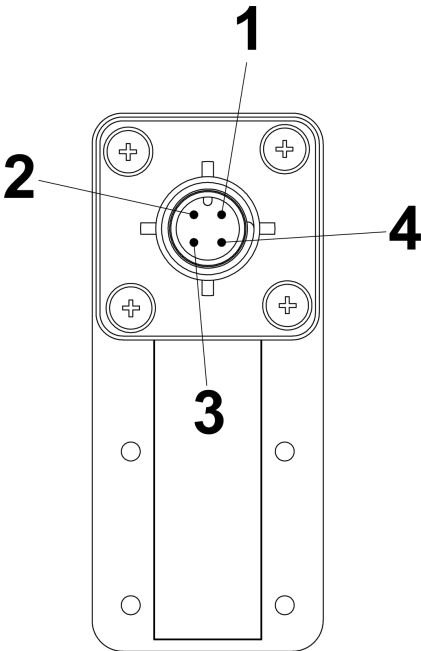

Fig. 17: Pin-assignment, socket M12x1 (Form 30x70)

Wiring diagram

Normally Open (NOC):

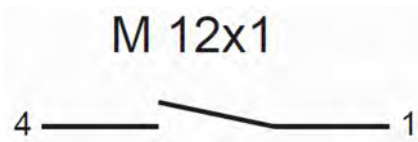

Fig. 18: Switch position under no-flow condition

Change Over (COC):

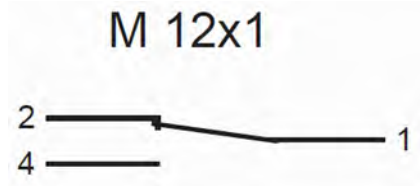

Fig. 19: Switch position under no-flow condition



### 5.6.3 Switch contact SG-30 with cable

The individual cores of the cable are numbered (basic version) or color coded (UL-version) according to the following connection diagrams.

#### Wiring diagram

**Normally Open (NOC):**

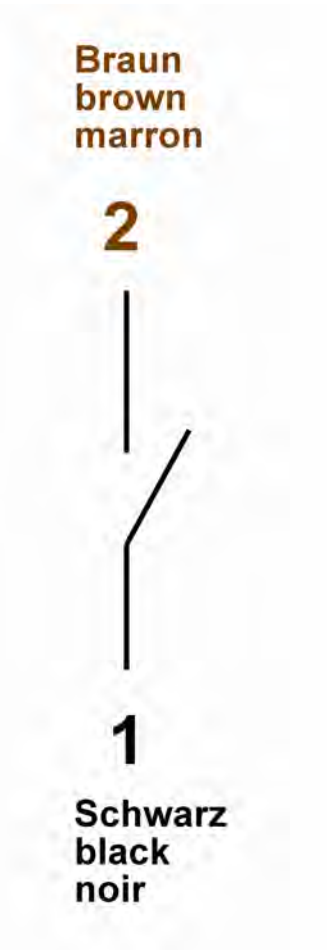

*Fig. 20: Switch position under no-flow condition*

**Change Over (COC):**

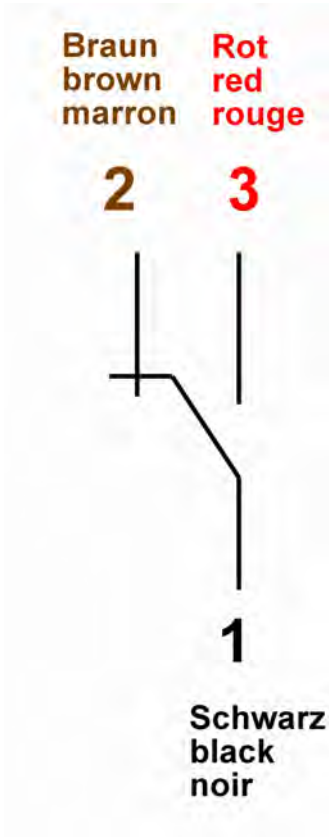

*Fig. 21: Switch position under no-flow condition*

**5.6.4 Degree of protection (IP-Code)**

The specified degree of protection (IP) is only ensured if approved connection material is used (see following table).

Device connection	Specification of connection material	Degree of protection
EN1753 01-803 with gland	Diameter of connection cable: 6–8 mm	IP65
M12x1	Plug connector M12x1	IP67
Cable	-	IP67

**5.7 Grounding the device**

When installing the device in a pipe system, ensure that the device is grounded to the pipe system to avoid a dangerous electrical potential difference.

## 5.8 Plug connection

### Personnel:

- Qualified electrician

### Tools:

- Flat-bladed screwdriver



Fig. 22: Detach socket

1. ➤ Release the fixing screw (Fig. 22) from the socket

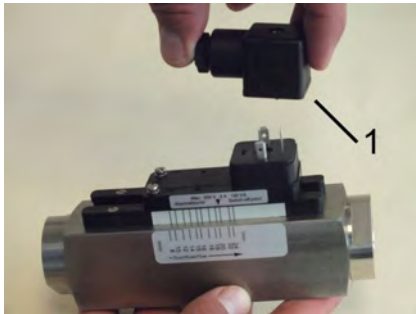

Fig. 23: Remove socket

2. ➤ Remove socket (Fig. 23/1)



Fig. 24: Loosen inner section

3. ➤ Loosen the inner section from the socket by inserting a flat-bladed screwdriver into the slot (Fig. 24/1) and carefully pry out the inner section.



Fig. 25: Loosen the screw connection

4. ➔ Unscrew the screw connection (Fig. 25/1) by turning in the direction of the arrow
5. ➔ Guide the connecting cable through the screw connection into the socket
6. ➔ Make the connections as shown in the connecting diagram (Fig. 26 and Fig. 27)
7. ➔ Place the inner section (Fig. 24) back into the socket and push until it locks on
8. ➔ Tighten the screw connection (Fig. 25/1) by turning it to the right until tight

9. ➔ Place the female socket onto the connecting plug and tighten the fixing screw (Fig. 23/1)

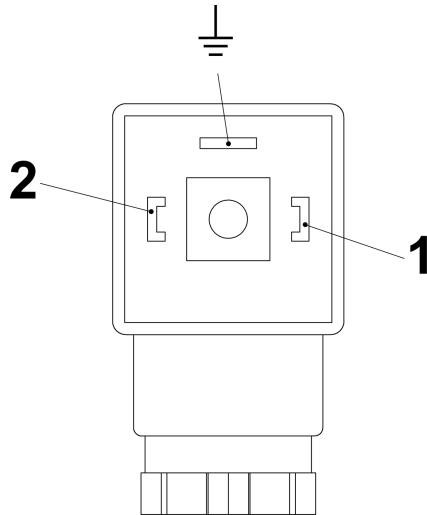

Fig. 26: Pin assignment, plug socket, normally-open contact (SG-30 with connector in compliance with EN175301-803)

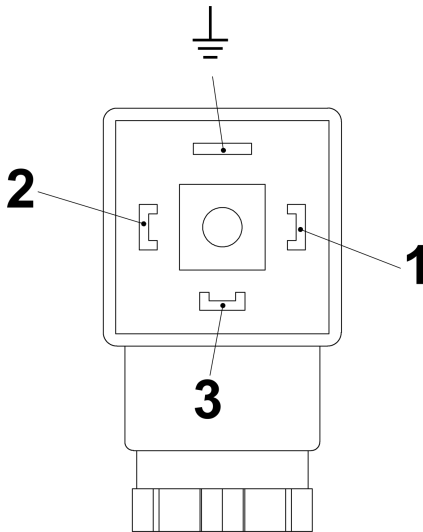

Fig. 27: Pin assignment, plug socket, change-over contact (SG-30 with connector in compliance with EN175301-803)

## 5.9 Contact protection measures

The Reed-switches used in the switch contacts are designed to be very sensitive to overload. To prevent destruction of the switch contact, the values specified on the rating plate of the switch contact must never be exceeded (not even temporarily).

There is a risk of overload from:

- inductive loads
- capacitive loads
- ohmic loads

Suitable measures must be taken to protect against overload (see following examples):

### Inductive load

There is danger of voltage peaks from inductive loads when switching off (up to 10 times the rated voltage). Inductive loads are caused by, e.g.:

- Contactors, relays
- Solenoid valves
- Electric motors

Examples of protective measures:

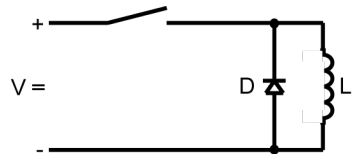

Fig. 28: Example 1

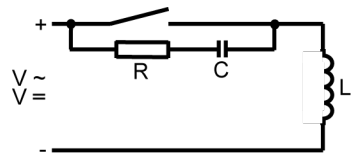

Fig. 29: Example 2

### Capacitive loads

There is a danger of high current peaks from capacitive loads when switching-on the switch contact (exceeding rated current). Capacitive loads are caused by, e.g.:

- Long connecting cables
- Capacitive consumers

Example of protective measure:

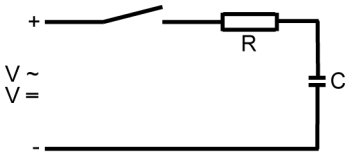

Fig. 30: Protective measure against capacitive loads

Fig. 32: Example 2

Protection against ohmic loads can be achieved through installation of a resistor in the circuit, or by heating the glow filament. For connection to high-impedance consumers (ex. PLC), a protective circuit is not needed.

### Ohmic loads

There is a danger of high current peaks from ohmic loads when switching-on the switch contact. The reason for this is that the glow filament has a low resistance at low temperatures. Ohmic loads are caused by, e.g.:

- Filament bulbs
- Motors during startup

Examples of protective measures:

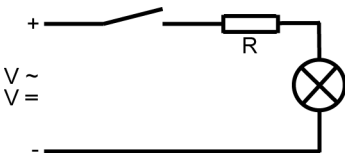
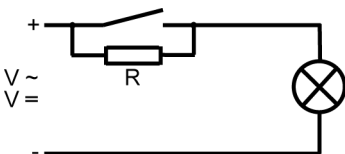

Fig. 31: Example 1



## 6 Operation

### 6.1 Setting the switch point

#### Setting the switch point of an installed device



The following instructions describe the procedure for a Normally Open Contact (NOC). The actual state (open or closed), can be determined using a continuity meter.

#### Personnel:

- Qualified personnel

#### Tools:

- Flat-bladed screwdriver

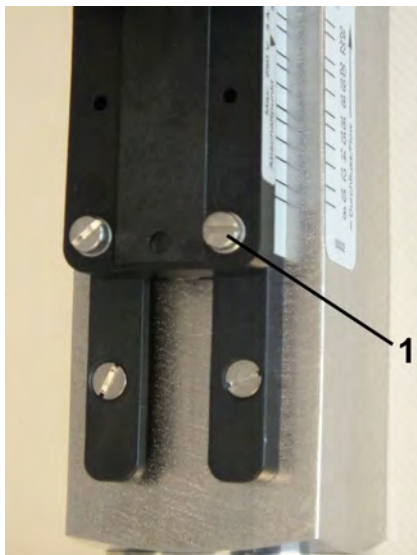

Fig. 33: Loosen set screws

1. Loosen the set screws of the switch contact (Fig. 33/1) using a flat-bladed screwdriver.
2. Set the switch contact to the flow value to be monitored. Make sure that the arrow on the switch contact data plate is in exact alignment with the desired flow rate on the switch point adjustment scale.
3. Tighten the set screws of the switch contact (/1) using a flat-bladed screwdriver. When doing so, observe the correct tightening torque of the screws.

🔗 Chapter 11.1 “Tightening torque” on page 86

- ⇒ The set switch point corresponds to the switch-off point of the switch contact by decreasing flow.

## Setting the switch point of a non-installed device



- ⇒ The set switch point corresponds to the switch-off point of the switch contact by decreasing flow.

Fig. 34: Loosen the set screws

1. Loosen the set screws of the switch contact (Fig. 34/1) using a flat-bladed screwdriver.
2. Set the switch contact to the flow value to be monitored. Make sure that the arrow on the switch contact data plate is in exact alignment with the desired flow rate on the switch point adjustment scale.
3. Tighten the set screws of the switch contact (Fig. 34/1) using a flat-bladed screwdriver. When doing so, observe the correct tightening torque of the screws.

🔗 Chapter 11.1 "Tightening torque" on page 86



## 6.2 Checking the flow

### Reading-off the switch value

#### Personnel:

- Qualified personnel

#### Protective equipment:

- Goggles

3.  Read-off the switch value from the switch point adjustment scale

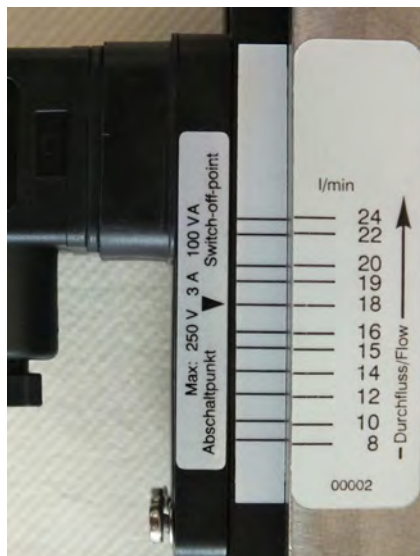



Fig. 35: Reading-off the switch point (example)

1.  Make sure that the setting arrow, the scale mark on the additional label on the guide rail and the scale mark of the switch point adjustment scale are in alignment. (Fig. 35)
2.  To obtain the greatest reading accuracy, read-off at eye level. The read-off value can be falsified by viewing at an angle from above or below (parallax error).

## 7 Troubleshooting

This chapter describes possible malfunctions of the device, their causes and repair.

If malfunctions persist or increase, shorten the maintenance interval to meet the actual operating conditions.

For malfunctions not described in this chapter, please contact the manufacturer (see service address on page 2).

### 7.1 Safety

#### Work performed incorrectly to remedy a malfunction



#### **WARNING!**

#### **Risk of injury due to incorrect repair of malfunction!**





Work performed incorrectly may result in severe injury and considerable damage to property.

- Ensure that the site is sufficiently cleared before commencing work
- Ensure that the repair location is orderly and clean! Components and tools that are lying about or on top of each other are potential causes of accidents
- If components have been removed, observe correct assembly procedures. Reinstall all fixing/fastening elements and observe the prescribed tightening torque for the screws  
↳ *Chapter 11.1 “Tightening torque” on page 86*
- Before placing the device back into operation, ensure that all work has been performed and completed in compliance with the specifications and instructions in these Operating Instructions

### Conduct in case of malfunction

The complete machine or system may be unsafe if there is a defect at the flow monitor (e.g. fractured housing).

The following always applies:

1.  In case of malfunctions that present an immediate danger to persons or valuables, proceed according to the valid emergency plans for the system
2.  Determine the cause of the malfunction
3.  Before repair, ensure that there is no danger to persons from escaping media
4.  If necessary, allow the pipeline and device to cool down or to warm up before commencing work
5.  Malfunctions must be corrected by qualified personnel



*The following troubleshooting guide provides an indication of who is qualified to repair the fault .*

## 7.2 Troubleshooting guide

Fault description	Cause	Remedy	Personnel
The switch contact does not switch	No medium flowing through flow monitor	Check that medium is flowing through the pipe-line	Qualified personnel
	Flow is too low or the switch contact is set too high	<ul style="list-style-type: none"> <li>■ Adjust the switch contact to a lower flow rate</li> <li>■ Use the device at another measuring range</li> <li>■ Increase the flow rate</li> </ul>	Qualified personnel
	Incorrect reduction fitting or pipe diameter is too small	<ul style="list-style-type: none"> <li>■ Correct pipe diameter</li> </ul>	Qualified personnel
	Float is stuck	Disassemble and clean the device	Qualified personnel
	Switch contact is defective	<ul style="list-style-type: none"> <li>■ Remedy the cause of the defect (short-circuit, overload)</li> <li>■ Replace the switch contact</li> </ul>	Qualified personnel
Switch contact is permanently switched	Flow is too high or the switch contact is set too low	<ul style="list-style-type: none"> <li>■ Reduce the flow</li> <li>■ Adjust the switch contact to a higher flow rate</li> <li>■ Use the device at another measuring range</li> </ul>	Qualified personnel
	Float is stuck	Disassemble and clean the device	Qualified personnel

<b>Fault description</b>	<b>Cause</b>	<b>Remedy</b>	<b>Personnel</b>
Switch contact is permanently switched	Switch contact is defective	<ul style="list-style-type: none"> <li>■ Remedy the cause of the defect (short-circuit, overload)</li> <li>■ Replace the switch contact</li> </ul>	Qualified personnel
The switch point is not the same as the actual flow rate	Improper scale installed for media used	Request proper conversion table or scale for media used	Qualified personnel
	Incorrect reduction fitting or pipe diameter is too small	<ul style="list-style-type: none"> <li>■ Correct pipe diameter</li> </ul>	Qualified personnel
	Device is dirty	Disassemble and clean the device	Qualified personnel
	Device is defective	Remove device from system and contact the manufacturer	Qualified personnel

## 8 Maintenance

### 8.1 Safety

#### Maintenance work performed incorrectly



#### **WARNING!**

#### **Risk of injury due to maintenance work performed incorrectly!**

Maintenance work performed incorrectly can result in severe injury and considerable damage to property.

- Ensure that the site is sufficiently cleared before commencing work.
- Ensure that the repair location is orderly and clean! Components and tools that are lying about or on top of each other are potential causes for accidents.
- If components have been removed, observe correct assembly procedure. Reinstall all fixing/fastening elements and observe the prescribed tightening torque for the screws (see Chapter 11.1).

- Before placing the device back into operation ensure that all work has been performed and completed in compliance with the specifications and instructions in these Operating Instructions.

### 8.2 Maintenance plan

#### Intervals for replacement of wear parts

DUM type flow monitors require very little maintenance due to the small number of moving parts. The intervals for the replacement of wear parts depends significantly on the operating conditions as well as on the composition of the medium flowing through the device. For this reason, no intervals have been set by the manufacturer. The operator must determine suitable intervals based on the local condition and circumstances.

Interval	Maintenance work	Personnel
	Visual inspection for dirt/soiling	Qualified personnel
	Visual inspection for free-movement of float	Qualified personnel
	Visual inspection for leaks from the device	Qualified personnel
	Check function of switch contact	Qualified personnel

### 8.3 Removal from the pipe system

The flow monitor must first be removed from the pipe system before performing maintenance.



**WARNING!**

**Risk of injury from pressurized lines!**

Severe injury may result if the pipe system is under pressure when removing the device.

- Depressurize the system before removing the device



**WARNING!**

**Risk of injury from hot or cold surfaces!**

Pipelines can heat up/cool down dramatically due to the media flowing through them. Skin contact with hot or cold surfaces causes severe skin burn or frostbite.

- Before removing the device, ensure that the machine or system and the flow monitor have been controlled to a temperature range between 0 and 40°C
- Do not touch any part of the machine or system that is either very hot or very cold
- Always wear heat-resistant/cold-resistant protective work clothing and protective gloves when working near hot/cold surfaces

 **WARNING!****Risk of injury from media in the pipe system!**

If the pipe system contains hazardous media, severe injury may be caused by escaping media.

- Before removing the device, ensure that the pipe system is empty and does not contain media residue
- Always wear personal protective equipment when removing the device

 **WARNING!****Risk of injury from media residue in the device!**

After the pipe system has been emptied, media residue may still be present inside the device. In the case of hazardous media, this could result in serious injury.

- When removing (de-installing the device from the pipe system), always wear personal protective equipment.
- All requirements specified in the media safety data sheet must be observed in accomplishing the work task.
- Residue of hazardous media in the device can result in serious injury.



## Removing the device from the pipe system

### Personnel:



- Qualified personnel

### Protective equipment:

- As specified in the Safety Data Sheet of the medium, **protective equipment** must be worn when handling hazardous media. In addition, the specifications of the system operator must be followed. If no protective equipment is specified, suitable protective gloves and goggles must be worn.

### Tools:

- Fixed spanner

1.  Loosen the adapter union of the pipeline using a suitable spanner. When doing so, lock the process connection or device body in place with a second spanner.
2.  Secure the device against falling and repeat Step 1 at the other process connection.

## 8.4 Disassembly

To replace wear parts or to clean the device, the flow monitor must first be disassembled.

### WARNING!

#### Risk of injury due to incorrect disassembly!

- The device may still contain media residue
- Wear personal protective equipment when working with hazardous media
- Improper disassembly may cause serious injury if hazardous media is still present inside the device

### CAUTION!

#### Risk of injury due to incorrect disassembly

Incorrect disassembly may result in injury.

- Before disassembling, ensure that the flow monitor has cooled down/ warmed up to a temperature range between 0 and 40 °C
- Wear personal protective equipment to protect against hazardous media which may still be present inside the device

**Protective equipment:**

- As specified in the Safety Data Sheet of the medium, **protective equipment** must be worn when handling hazardous media. In addition, the specifications of the system operator must be followed. If no protective equipment is specified, suitable protective gloves and goggles must be worn.

**Personnel:**

- Qualified personnel

**Protective equipment:**

- Goggles
- Protective gloves

**Tools:**

- Fixed spanner
- Socket wrench

**Special tools:**

- Threaded ring insertion tool



*Fig. 36: Loosen process connection (outlet)*

1.  Loosen the process connection (outlet) (Fig. 36) using the proper sized fixed spanner wrench. Hold the device body in place using a proper sized spanner wrench.



*Fig. 37: Remove the process connection (outlet)*

2.  2. Unscrew the process connection (outlet) from the device body (Fig. 37). If necessary, remove the O-ring from the process connection.



*Fig. 38: Remove the centering disc (outlet)*

3.  3. Remove the centering disc (outlet) from the slot nozzle (Fig. 38)



*Fig. 39: Remove inner parts*

4.  4. Carefully turn the device body 180° and remove the inner parts (slot nozzle, spring, float and inlet centering disc). (Fig. 39)

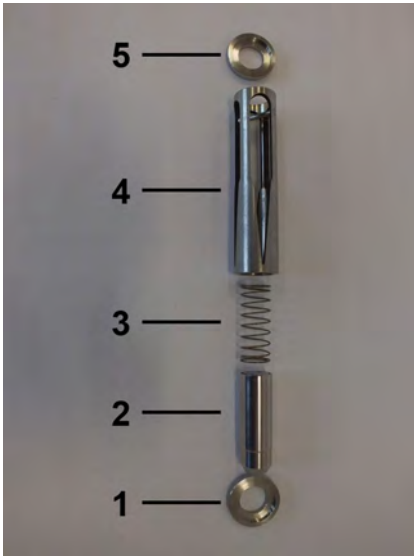

Fig. 40: Inner parts DUM

**5.** The inner parts of the flow monitor consist of the centering disc (inlet) (Fig. 40/1), float (Fig. 40/2), spring (Fig. 40/3), slot nozzle (Fig. 40/4) and centering disc (outlet) (Fig. 40/5).



Fig. 41: Loosen process connection (inlet)

**6.** 6. Loosen the process connection (inlet) (Fig. 39) (Fig. 41) using the proper sized fixed spanner wrench. Hold the device body in place using a proper sized spanner wrench.



Fig. 42: Remove the process connection (inlet)

7.  7. Unscrew the process connection (inlet) from the device body (Fig. 42). If necessary, remove the O-ring from the process connection.

 **O-ring replacement**

*It is recommended that the O-rings be replaced during maintenance.*

## 8.5.1 Cleaning

It is the responsibility of the operator to establish appropriate intervals and procedures for cleaning the individual parts of the device. It must be ensured that the parts are not damaged during the cleaning process. When using cleaning agents, it must be ensured that these are not aggressive to the parts and that there will be no dangerous reactions with media residue. Damaged parts must be replaced.

 **WARNING!**

**Risk of injury due to improper cleaning!**

The device may still contain media residue.

- To protect against hazardous media residue in the device, wear personal protective equipment.
- Do not use cleaning agents which may lead to dangerous reactions with media residue.
- All requirements specified in the safety data sheet must be observed when handling or otherwise using the medium.
- Residue of hazardous media inside the device can cause serious injury.

## 8.5 Maintenance

**CAUTION!****Risk of injury due to damaged parts!**

If parts of the device are broken or damaged, they may cause injury due to sharp edges or splinters during the cleaning process.

- Damaged parts must be replaced
- Carefully clean the parts of the device, so as not to cause damage
- When cleaning, always wear appropriate personal protective equipment
- Incorrect disassembly can result in injuries

**Protective equipment:**

- As specified in the Safety Data Sheet of the medium, **protective equipment** must be worn when handling hazardous media. In addition, the specifications of the system operator must be followed. If no protective equipment is specified, suitable protective gloves and goggles must be worn.

**8.5.2 Parts replacement**

Depending on the operating conditions, wear parts such as O-rings, float or magnets may have to be replaced. Steps required to replace these parts correspond to those used when assembling the device ↪ *Chapter 8.5.3 “Assembly” on page 62.*

**8.5.3 Assembly**

After cleaning the individual components, the flow monitor must be reassembled.

**Personnel:**

- Qualified personnel

**Tools:**

- Flat-bladed screwdriver
- Torque screwdriver and assorted blades
- Fixed spanner
- Socket wrench
- Torque wrench

**Special tools:**

- Threaded ring insertion tool
- Test rod
- O-Ring installation tool
- Magnetic pole indicator



Fig. 43: O-ring (seal)

1. Carefully install the O-rings (Fig. 43/2) with the aid of the O-ring installation tool (Fig. 43/1) onto the process connections (inlet and outlet), so that they are properly seated in the O-ring grooves of the process connection (Fig. 43/1). When doing so, be careful not to overstretch the O-rings

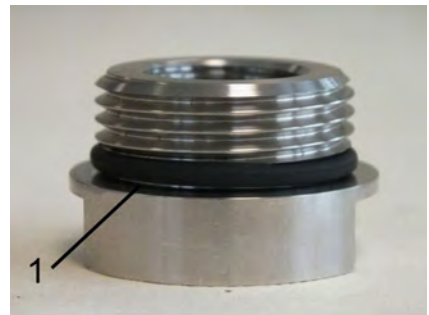



Fig. 44: Properly positioned O-ring

2. Position the O-ring properly on the process connection (Fig. 44/1)
3. Lubricate the O-rings lightly



A list of suitable lubricants is contained in the annex  Chapter 11.5 "Lubricants" on page 93.



*Fig. 45: Insert process connection (inlet)*

4. ➤ Insert the process connection (inlet) into the device body (inlet) (Fig. 45)



*Fig. 46: Tighten process connection (inlet)*

5. ➤ Using a proper sized fixed spanner tighten the process connection (inlet). Hold the device body in place using a suitable fixed spanner (Fig. 46), and observe the proper torque (  Chapter 11.1 "Tightening torque" on page 86)



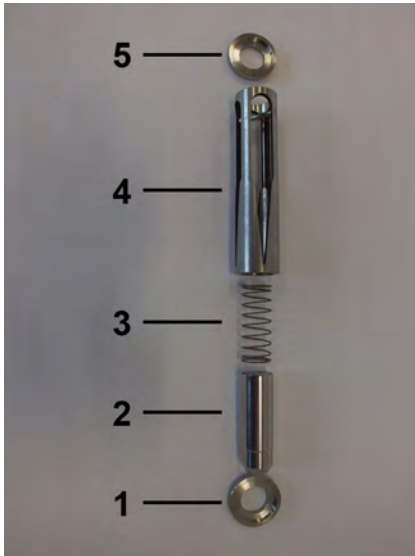

Fig. 47: Inner parts

6. ➤ The inner parts of the flow monitor consists of the centering disc (inlet) (Fig. 47/1), float (Fig. 47/2), spring (Fig. 47/3), slot nozzle (Fig. 47/4) and centering disc (outlet) (Fig. 47/5)



Fig. 48: Insert inner parts

7. ➤ Insert centering disc (inlet), float, spring and slot nozzle into the device body (Fig. 48)



Fig. 49: insert centering disc (outlet)

8. ➤ Insert the centering disc (outlet) over the slot nozzle, so that the collar with the small diameter is pointing toward the device outlet (Fig. 49)



*Fig. 50: Insert process connection (outlet)*

- 9.** ➤ Insert the process connection (outlet) into the device body (Fig. 50)



*Fig. 51: Tighten process connection (outlet)*

- 10.** ➤ Using a proper sized fixed spanner, tighten the process connection (outlet). Hold the device body in place using a suitable fixed spanner (Fig. 51), and observe the proper torque (  Chapter 11.1 "Tightening torque" on page 86)



Fig. 52: Check for smooth operation

11. ➤ Check the float for ease of movement (Fig. 52) by applying light pressure with the test rod
  - ⇒ If the float is sluggish, disassemble the device
    - ↳ Chapter 9.2 “Disassembly” on page 71 and clean the float and device body bore



*If the float is still sluggish after having been cleaned several times, contact the manufacturer.*

## 8.5.4 Switch contact replacement

### Tools:

- Flat-bladed screwdriver

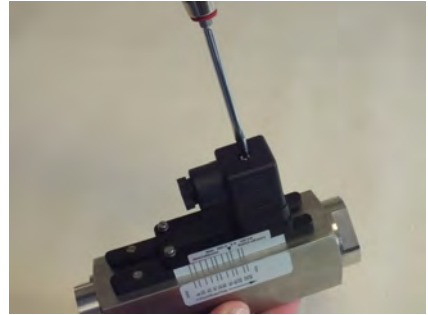

Fig. 53: Loosen female socket

1. ➤ Loosen the fixing screw of the female socket (Fig. 53) with a flat-bladed screwdriver

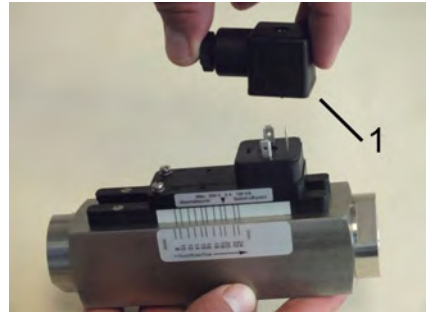

Fig. 54: Remove female socket

2. ➤ Remove the female socket and gasket (Fig. 54/01) by pulling upwards



*Fig. 55: Loosen set screws*

- 3.** Using a flat-bladed screwdriver (Fig. 55/01) loosen the set screws of the switch contact until it moves freely

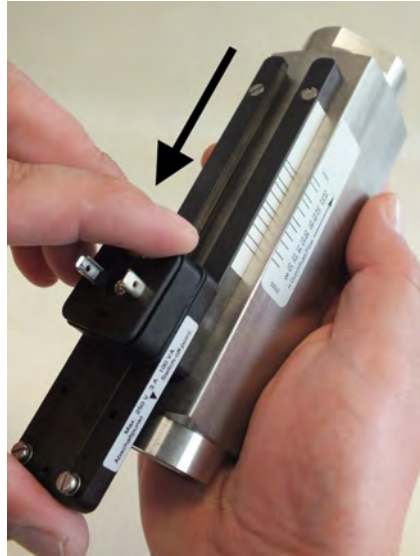

*Fig. 56: Remove the switch contact from guide rails*

- 4.** Slide the switch contact from the guide rail (Fig. 56) in the direction of the arrow





Fig. 57: Remove switch contact

5. ➤ Remove the switch contact from the device
6. ➤ Position the new switch contact
7. ➤ Slide the switch contact onto the guide rails
8. ➤ Connect a continuity meter. For Normally Open Contact (NOC), pin 1 and pin 2 are assigned; for Change Over Contact (COC), pin 1 and pin 3 are assigned
9. ➤ Slide the switch contact in the opposite direction of flow up to the stop. The switch contact must now be closed.
10. ➤ Slowly push the switch contact in the direction of flow until the contact opens. This switch point should be set as precisely as possible because it affects the accuracy of the switch point adjustment scale values (if needed, repeat steps 9 and 10).
11. ➤ Tighten the set screws (Fig. 55/01) observing the tightening torque of the screws (  Chapter 11.1 "Tightening torque" on page 86)
12. ➤ Affix the enclosed switch contact label to the side of the switch contact so that the reference arrow is aligned with the lowest scale mark. If a reference tick mark is on the data plate (recognizable as a thinner line), it is to be used as the alignment mark. The adhesive surface must be dry and free of oil and grease.
13. ➤ Adjust the desired flow rate (cut-off point) on the switch point adjustment scale
14. ➤ Attach the female socket and gasket and tighten the fixing screw

## 8.6 Measures to be taken after maintenance work

Take the following steps after completion of maintenance work and before switching on the device:

1.  Check all previously loosened/ released screw connections for tightness.  
*↳ Chapter 11.1 "Tightening torque" on page 86*
2.  Clean the work area and remove all residual materials, packaging, substances or spills.

## 9 Disassembly and disposal

After its period of useful life, the device must be disassembled and disposed of in an environmentally safe manner.

### 9.1 Safety



#### WARNING!

#### Risk of injury if disassembled incorrectly!

Media residue, sharp edged components, pointed ends and corners on and in the device or on tools may cause injury.

- Ensure that the site is sufficiently cleared before commencing work
- Always wear protective equipment when handling hazardous media residue
- Handle open, or sharp-edged components carefully
- Ensure that the workplace is orderly and clean! Components and tools that are lying about or on top of each other are potential causes for accidents
- Disassemble components professionally
- Secure components so that they do not fall or overturn
- If in doubt, contact the manufacturer

### 9.2 Disassembly

Before starting disassembly:



- Remove operating materials and supplementary supplies and dispose of properly.

#### Personnel:

- Qualified personnel

#### Protective equipment:

- Protective gloves
- Goggles

1. ➤ Remove the device from the pipeline (  Chapter 8.3 "Removal from the pipe system" on page 55)
2. ➤ Disassemble the device (  Chapter 8.4 "Disassembly" on page 57)
3. ➤ Clean components properly and remove media residue
4. ➤ Dispose properly

### 9.3 Return Materials

#### 9.3.1 Return Materials Authorization

For products being returned, regardless of the reason, the currently valid provisions of the returns policy set by MEISTER will apply. Return shipments which do not comply with the returns policy may be refused by MEISTER at the expense of the consignor.

## 9.4 Disposal

If no return or disposal agreement has been made, recycle disassembled components:

- Scrap metals
- Recycle plastic elements
- Dispose of the remaining components according to their material properties

### NOTICE!

#### **Danger to the environment due to incorrect disposal!**

Potential risk to the environment may arise due to incorrect disposal.

- Have electrical scrap, electronic components, lubricants and other supplies disposed of by approved specialists
- In case of doubt, obtain information on environmentally safe disposal from the local authority or special disposal expert



## 10 Technical data

### 10.1 Device data plate

The data plate is on the mechanical part of the flow monitor/flowmeter and contains the following information:



Fig. 58: Device data plate

### 10.2 Switch contact data plate

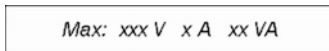

Fig. 59: Switch contact rating plate

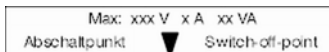

Fig. 60: Switch contact rating plate with positioning arrow

The rating plate is on the switch contact and may provide the following information:

- maximum voltage
- maximum current
- maximum power
- positioning arrow for cut-off point

### 10.2.1 Switch contact data plate for UL Recognized switch contacts



Fig. 61: Switch contact data plate



Fig. 62: Adhesive label, switch contact with positioning arrow

The data plate is on the switch contact and may provide the following information:

- Type of current (AC or DC)
- Maximum voltage
- Maximum current
- Maximum power
- Frequency

For UL Recognized switch contacts SG-30, with connector in compliance with EN 175301-803:

- temperature rating for the connection cable

### 10.3 Dimension sheet

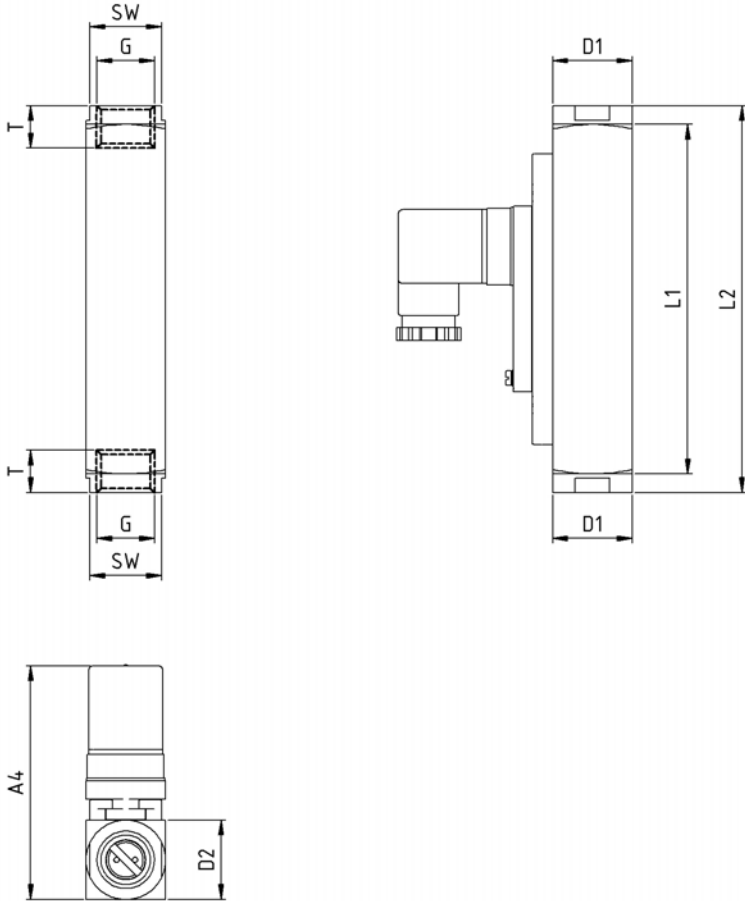

Fig. 63: Type DUM-55

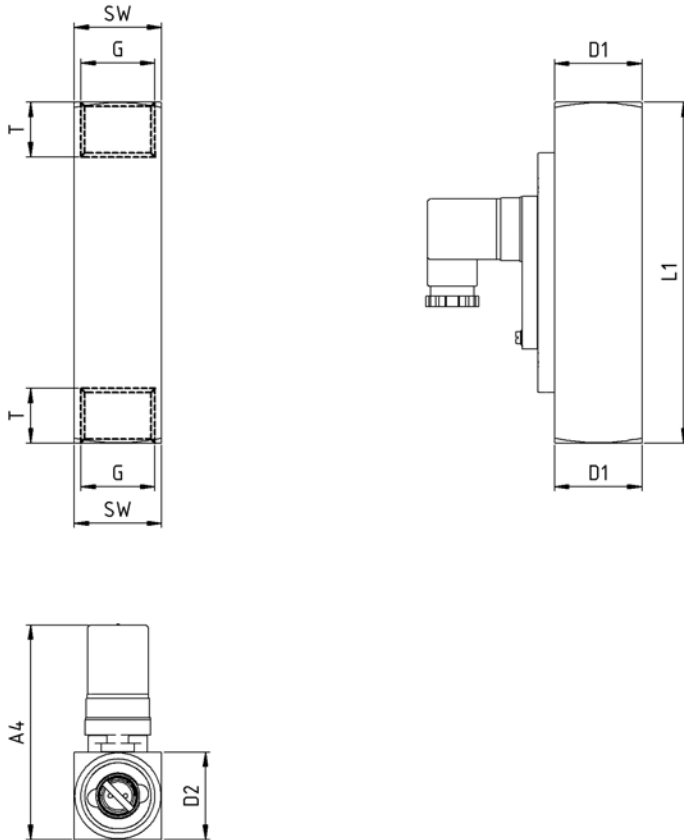

Fig. 64: Type DUM-90

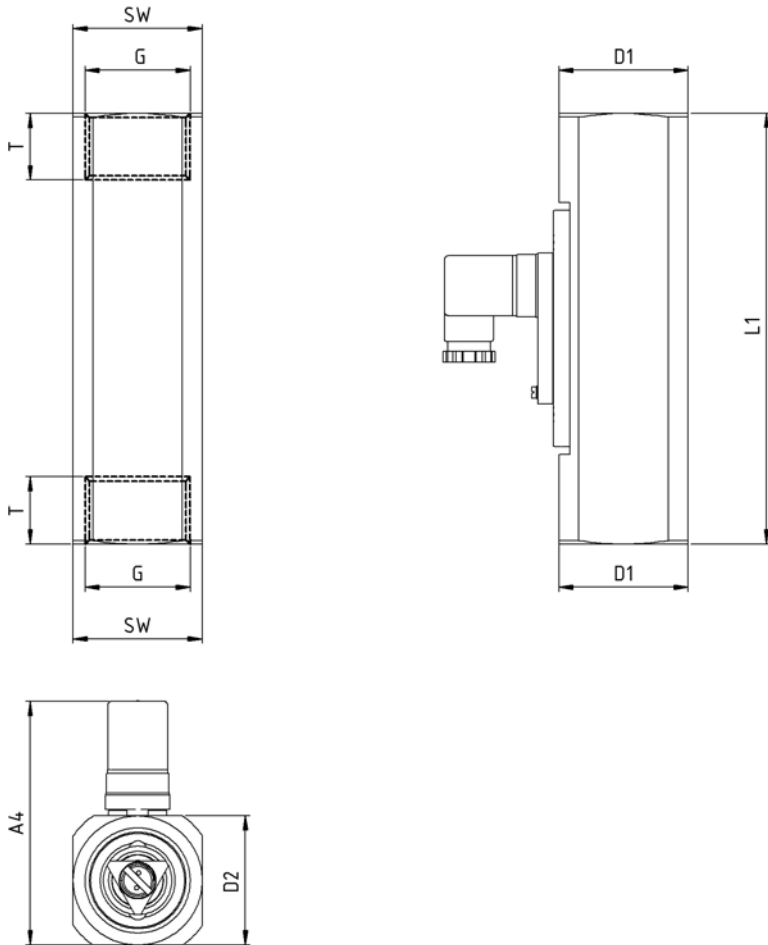

Fig. 65: Type DUM-220 ATEX and DUM-250

## 10.4 General specifications

Type	Overall dimensions (mm)					
	G	DN	SW	L1	L2	T
DUM-4	1/4"	8	27	117	131	10
	3/8"	10	27	117	131	15
	1/2"	15	27	117	131	14
DUM-5	1/4"	8	27	117	131	10
	3/8"	10	27	117	131	15
	1/2"	15	27	117	131	14
DUM-8	1/4"	8	27	117	131	10
	3/8"	10	27	117	131	15
	1/2"	15	27	117	131	14
DUM-14	1/4"	8	27	117	131	10
	3/8"	10	27	117	131	15
	1/2"	15	27	117	131	14
DUM-28	1/4"	8	27	117	131	10
	3/8"	10	27	117	131	15
	1/2"	15	27	117	131	14
DUM-40	1/2"	15	27	132	146	14
	3/4"	20	27	132	146	14
DUM-55	1/2"	15	32	132	174	15
	3/4"	20	32	132	174	15
DUM-70	3/4"	20	40	130	152	15
	1"	25	40	156	156	17
DUM-90	3/4"	20	40	130	152	15

Type	Overall dimensions (mm)					
	G	DN	SW	L1	L2	T
	1"	25	40	156	156	17
DUM-110	3/4"	20	40	130	152	15
	1"	25	40	156	156	17
DUM-150	1 1/4"	32	50	200	200	20
DUM-220	1 1/4"	32	50	200	200	20
	1 1/2"	40	60	200	200	20
DUM-250	1 1/4"	32	50	200	200	20
	1 1/2"	40	60	200	200	20

Type	Overall dimensions (mm)							
	G	D1	D2	A1	A2	A3	A4	Weight (g)
DUM-4	1/4"	30	30	-	-	-	88	850
	3/8"	30	30	-	-	-	88	850
	1/2"	30	30	-	-	-	88	850
DUM-5	1/4"	30	30	-	-	-	88	850
	3/8"	30	30	-	-	-	88	850
	1/2"	30	30	-	-	-	88	850
DUM-8	1/4"	30	30	-	-	-	88	850
	3/8"	30	30	-	-	-	88	850
	1/2"	30	30	-	-	-	88	850
DUM-14	1/4"	30	30	-	-	-	88	850
	3/8"	30	30	-	-	-	88	850

Type	Overall dimensions (mm)							
	G	D1	D2	A1	A2	A3	A4	Weight (g)
	1/2"	30	30	-	-	-	88	850
DUM-28	1/4"	30	30	-	-	-	88	850
	3/8"	30	30	-	-	-	88	850
	1/2"	30	30	-	-	-	88	850
DUM-40	1/2"	30	30	-	-	-	88	900
	3/4"	30	30	-	-	-	88	900
DUM-55	1/2"	35	30	-	-	-	88	900
	3/4"	35	30	-	-	-	98	900
DUM-70	3/4"	40	40	-	-	-	98	1400
	1"	40	40	-	-	-	98	1100
DUM-90	3/4"	40	40	-	-	-	98	1400
	1"	40	40	-	-	-	98	1100
DUM-110	3/4"	40	40	-	-	-	108	1400
	1"	40	40	-	-	-	108	1100
DUM-150	1 1/4"	50	50	-	-	-	108	2750
DUM-220	1 1/4"	50	50	-	-	-	108	3000
	1 1/2"	60	60	-	-	-	116	3800
DUM-250	1 1/4"	50	50	-	-	-	108	3000
	1 1/2"	60	60	-	-	-	116	3800



*NPT threads are available on request.*

*The weight of the connection cable at a length of 2m is approx. 80 g*

## 10.5 Electrical specifications

### Change-Over Contact (COC)

Data	Value	Unit
Voltage	250	V
Current, maximum	1,5	A
Power, maximum	50	VA
Minimum load	3	VA

### Normally Open contact (NOC)

Data	Value	Unit
Voltage	250	V
Current, maximum	3	A
Power, maximum	100	VA



**Change-Over Contact (COC) M12x1 (-20 °C–85 °C)**

Data	Value	Unit
Voltage	250	V
Current, maximum	1,5	A
Power, maximum	50	VA
Minimum load	3	VA

**Normally Open contact (NOC) M12x1 (-20 °C–85 °C)**

Data	Value	Unit
Voltage	250	V
Current, maximum	3	A
Power, maximum	100	VA

**Change-Over Contact (COC), PLC**

Data	Value	Unit
Voltage	250	V
Current, maximum	1	A
Power, maximum	60	VA

## 10.5.1 Electrical specifications for UL Recognized devices

### Change-Over Contact (COC)

Data	Value	Unit
Voltage	240	V AC/DC
Current, maximum	1,5	A
Power, maximum	50	VA
Minimum load	3	VA
Frequency	50/60	Hz

### Normally Open Contact (NOC)

Data	Value	Unit
Voltage	250	V AC/DC
Current, maximum	3	A
Power, maximum	100	VA
Frequency	50/60	Hz

## 10.6 Measuring ranges

### 10.6.1 Standard measuring ranges

Type	Switch range for H <sub>2</sub> O at 20 °C		
	l/min	gph	gpm
DUM-4	0,2 – 4	3,0 – 63,5	–
DUM-5	0,6 – 5	9,5 – 79,0	–

Type	Switch range for H <sub>2</sub> O at 20 °C		
	l/min	gph	gpm
DUM-8	0,5 – 8	8,0 – 127,0	–
DUM-14	1 – 14	15,0 – 222,0	–
DUM-28	1 – 28	15,0 – 445,0	–
DUM-40	2 – 40	30,0 – 635,0	–
DUM-55	4 – 55	60,0 – 870,0	–
DUM-70	1 – 70	–	0,3 – 18,5
DUM-90	8 – 90	–	2,1 – 23,8
DUM-110	5 – 110	–	1,3 – 29,0
DUM-150	10 – 150	–	2,6 – 39,5
DUM-220	35 – 220	–	9,0 – 58,0
DUM-250	35 – 250	–	9,0 – 66,0



*The specified data are switch-off points. Other switch ranges are available on request.*

## 10.7 Operating data

Description	Value	Unit
Pressure loss	0,02 – 0,8	bar
Max. media temp.	100 (optional: 160)	°C
Max. media temp. for UL Recognized Components	100	°C
Measuring accuracy	± 5 % of full scale value	

Description	Value	Unit
Min. media temp.	-20	°C
Min. media temp. for UL Recognized Components.	-15	°C

**Max. Operating pressure**

Type	Brass	Stainless steel	Brass UL Recognized Components	Stainless steel UL Recognized Components
DUM-4	200 bar	300 bar	120 bar	250 bar
DUM-5	200 bar	300 bar	120 bar	250 bar
DUM-8	200 bar	300 bar	120 bar	250 bar
DUM-14	200 bar	300 bar	120 bar	250 bar
DUM-28	200 bar	300 bar	120 bar	250 bar
DUM-40	200 bar	300 bar	120 bar	250 bar
DUM-55	200 bar	300 bar	120 bar	250 bar
DUM-70	200 bar	300 bar	150 bar	300 bar
DUM-90	200 bar	300 bar	150 bar	300 bar
DUM-110	200 bar	300 bar	150 bar	300 bar
DUM-150	200 bar	300 bar	150 bar	170 bar
DUM-220 G 1 1/4"	200 bar	300 bar	150 bar	170 bar
DUM-220 G 1 1/2"	200 bar	300 bar	90 bar	300 bar
DUM-250 G 1 1/4"	200 bar	300 bar	150 bar	170 bar
DUM-250 G 1 1/2"	200 bar	300 bar	90 bar	300 bar

**Operating conditions for UL Recognized Components**

Description	Value	Unit
<b>Indoor use</b>		
Altitude	Up to 2 000	m
Temperature	-15 to 100	°C
Max.relative humidity	80 % for temperatures up to 31 °C decreasing linearly to 50 % relative humidity at 40 °C	
Mains supply voltage fluctuations	Up to +/-10 % voltage	
Overvoltage category	II	
Pollution degree	2	

**! NOTICE!**

It must be ensured that the medium does not freeze.

Operating data for devices employed in explosion hazard zones differs from the above and are specified in the Operating Instructions for "DUM Module ATEX, Chapter 4.

# 11 Annex

## 11.1 Tightening torque

Component/ function	Description	Size	Torque	Qty
Threaded ring	Threaded ring (inlet/outlet)	G1"	40 Nm	2
Threaded ring	Threaded ring (inlet/outlet)	G5/4"	10 Nm	2
Threaded ring	Threaded ring (inlet/outlet)	G6/4"	10 Nm	2
Process con- nection	Process con- nection (inlet/ outlet)	G1"	40 Nm	2
Guide rail screw	Countersunk screw with slot	M3x10	0,4 Nm	4
Switch contact	Cylinder head screw with slot	M3x8	0,4 Nm	2

## 11.2 Replacement parts list

The following replacement parts drawing provides an example of the construction of a DUM type flow monitor. The actual configuration may vary depending on the model.

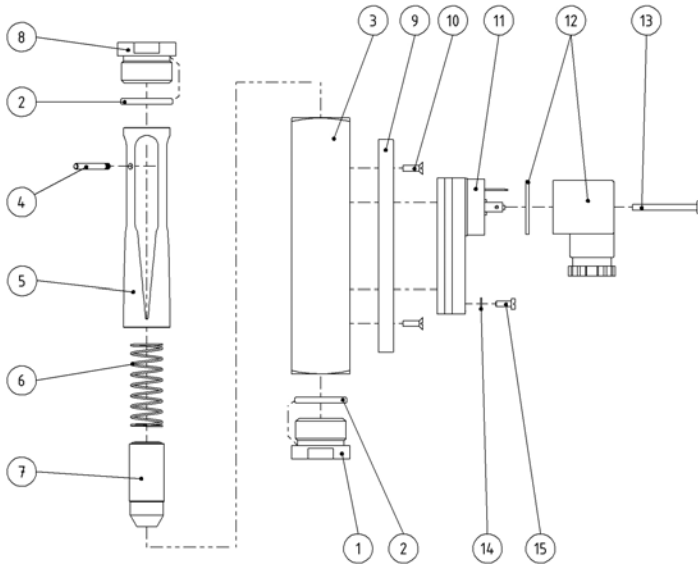

Fig. 66: Type DUM-55

Item	Qty	Description
1	1	Process connection (inlet)
2	2	O-ring (seal)
3	1	device body
4	1	Pin (outlet) slot nozzle
5	1	Slot nozzle

<b>Item</b>	<b>Qty</b>	<b>Description</b>
6	1	Spring
7	1	Float
8	1	Process connection (outlet)
9	2	Guide rail
10	4	Fixing screws, (guide rail)
11	1	Switch contact with male connector
12	1	Female socket and gasket
13	1	Fixing screw (female socket)
14	2	Washer
15	2	Set screw (switch contact)



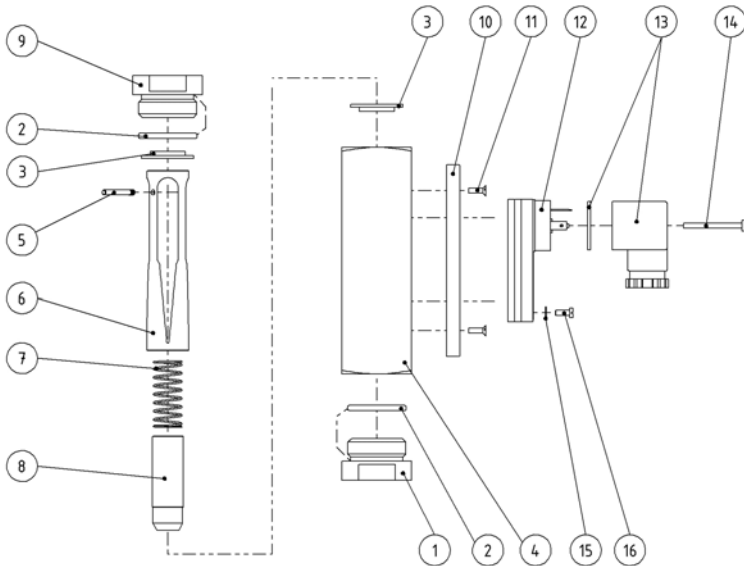

Fig. 67: Type DUM-90

Item	Qty	Description
1	1	Process connection (inlet)
2	2	O-ring (seal)
3	2	Centering disc
4	1	Device body
5	1	Pin (outlet) slot nozzle
6	1	Slot nozzle
7	1	Spring

Item	Qty	Description
8	1	Float
9	1	Process connection (outlet)
10	2	Guide rail
11	4	Fixing screws, (guide rail)
12	1	Switch contact with male connector
13	1	Female socket and gasket
14	1	Fixing screw (female socket)
15	2	Washer
16	2	Set screw (switch contact)

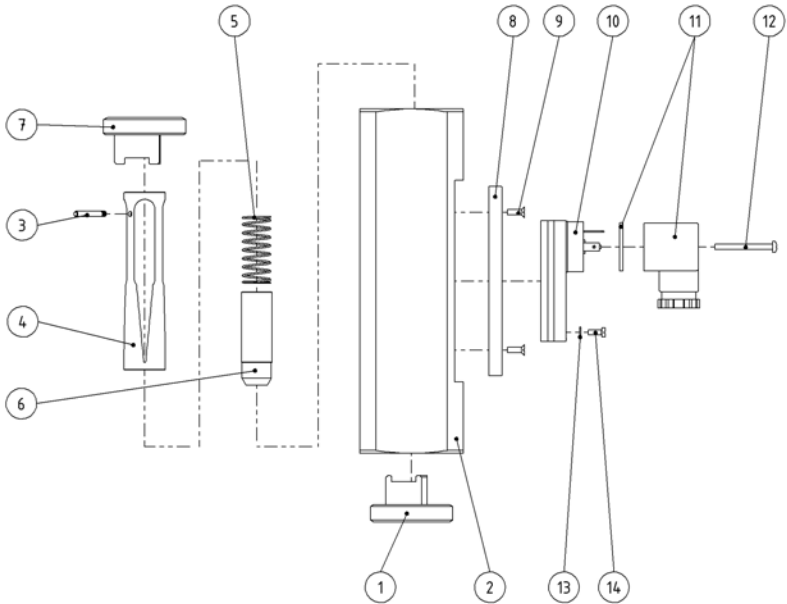

Fig. 68: Type DUM-220 and DUM-250

Item	Qty	Description
1	1	Threaded ring (inlet)
2	1	Device body
3	1	Pin (outlet) slot nozzle
4	1	Slot nozzle
5	1	Spring
6	1	Float

Item	Qty	Description
7	1	Threaded ring (outlet)
8	2	Guide rail
9	4	Fixing screws, (guide rail)
10	1	Switch contact with male connector
11	1	Female socket and gasket
12	1	Fixing screw (female socket)
13	2	Washer
14	2	Set screw (switch contact)

### 11.3 Tools

The following tools are required:

#### Tool

- Fixed spanner 30, 35, 41, 50, 60 mm
- Flat-bladed screw driver, blade width 5,5 mm
- Torque screwdriver and assorted blades
- Socket wrench ½" and assorted sockets
- Torque wrench ½"

#### Special tools

- Threaded ring insertion tool for DUM (DUM-150 and higher)
- Test rod DUM
- O-Ring installation tool for DUM

### 11.4 Sealant



*Before using a sealant, ensure that it is compatible with the media used and that it can be employed under the given operating conditions.*

- Ensure proper seal
- Use a suitable sealant. Liquid sealants will damage the flow monitor
- Always follow the sealant manufacturer's instructions

## 11.5 Lubricants



*Before using a lubricant, always make sure that it is compatible with the operating medium.*

For the proper mounting of O-rings, device-specific O-ring installation tools may be purchased from the manufacturer.

The following lubricants are suitable to facilitate installing the O-rings:

Lubricant	O-ring material		
	NBR	EPDM	FKM
Glycerine	suitable	suitable	suitable
Soapy water	suitable	suitable	suitable

### **!** NOTICE!

Glycerine must not be used if the device is used for sulfuric acid and/or nitric acid.

## 12 Index

<b>A</b>	
Application . . . . .	13
Assembly . . . . .	62
<b>C</b>	
Cable . . . . .	41
Component groups . . . . .	24
Connector	
EN175301-803 . . . . .	39
Contact . . . . .	10
Contact protection measures . . . . .	45
Copyright . . . . .	3
Correct use in accordance with these instructions . . . . .	13
Customer service . . . . .	10
<b>D</b>	
Degree of protection	
IP-Code . . . . .	42
Device data plate . . . . .	73
Device description . . . . .	23
Dimension sheet . . . . .	74
Disassembly	
disposal . . . . .	71
maintenance . . . . .	57
Disposal . . . . .	72
<b>E</b>	
Electrical connection . . . . .	38
Electrical specifications	
UL Recognized . . . . .	82
Environmental protection . . . . .	20
cleaning fluids . . . . .	20
lubricants . . . . .	21
<b>F</b>	
Fault table . . . . .	52
<b>G</b>	
General	
safety . . . . .	11
<b>H</b>	
Hazard	
electrical current . . . . .	15
Hazards	
mechanical . . . . .	16
media . . . . .	17
radiation . . . . .	17
temperature . . . . .	16
<b>I</b>	
Initial startup . . . . .	37
Installation	
pipe system . . . . .	33
Preparatory work . . . . .	29
<b>L</b>	
Limitation of liability . . . . .	3
Lubricant . . . . .	93
<b>M</b>	
Maintenance . . . . .	61

Maintenance plan . . . . .	55	Service . . . . .	10
Measuring range . . . . .	82	Special tools . . . . .	92
<b>O</b>		Storage . . . . .	26
Operating conditions . . . . .	83	Strainer . . . . .	32
Overview . . . . .	23	Switch contact . . . . .	24
Owner . . . . .	21	replacement . . . . .	67
<b>P</b>		Switch contact data plate	
Packaging . . . . .	25	UL Recognized . . . . .	73
Parts replacement . . . . .	62	Switch contact rating plate . . . . .	73
Plug connection . . . . .	43	Switch point adjustment scale . . . . .	24
Plug connector		Switch point setting . . . . .	47
M12x1 . . . . .	40	Switch value . . . . .	49
Precautions		Symbols	
general . . . . .	14	packaging . . . . .	26
Preparation		Symbols used	
device . . . . .	32	in the instructions . . . . .	11
<b>R</b>		<b>T</b>	
Read-off . . . . .	49	Technical data	
Replacement parts . . . . .	20, 86	general specifications . . . . .	77
Return Materials Authorization . . . . .	71	Tightening torque . . . . .	86
<b>S</b>		Tightening torque of screws . . . . .	86
Safety		Tools . . . . .	92
disassembly . . . . .	71	Transport inspection . . . . .	25
Safety equipment . . . . .	18, 19	<b>U</b>	
Safety instructions		Unimpeded flow section . . . . .	30
transport . . . . .	25	<b>W</b>	
Sealant . . . . .	92	Warranty and guarantee provisions	10