

Operating Instructions

WBMC Module BASICS

Flow Monitor

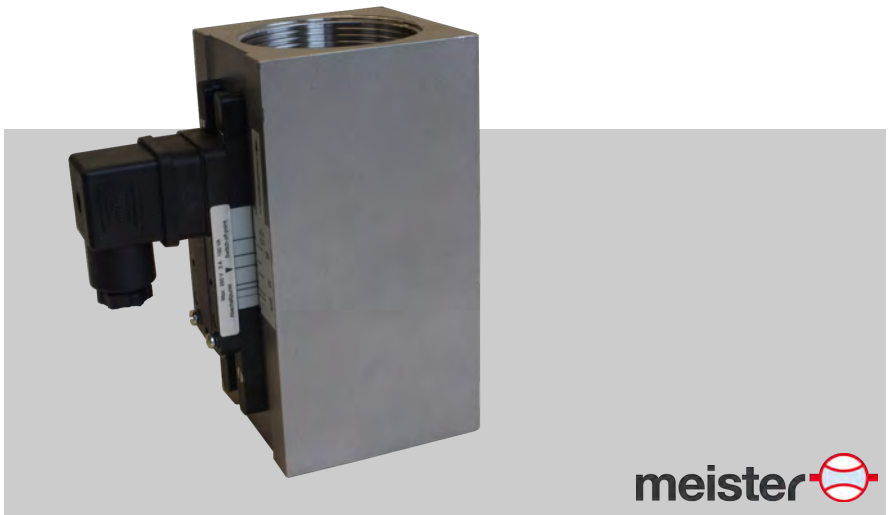

Series WBMC

Type WBMC 8 m³/h thru 20 m³/h

Read the instructions prior to performing any task!

Meister Strömungstechnik GmbH
Im Gewerbegebiet 2
63831 Wiesen
Germany
Telephone: +49 6096 9720 - 0
Fax: +49 6096 9720 - 30
Email: sales@meister-flow.com
Internet: www.meister-flow.com

WBMC Module BASICS, 1, en_US

These instructions were compiled by:
Meister Strömungstechnik GmbH
Subject to change without notice

© Meister Strömungstechnik GmbH 2014

These instructions facilitate the safe and efficient handling of a flow monitor (referred to as "device" in the following). The instructions are an integral part of the device and must be kept within easy reach for the personnel in the immediate vicinity of the device at all times. Personnel must carefully read and understand these instructions before commencing all work. The basic requirement for safe work is adherence to all safety and handling instructions stipulated in these instructions. The local accident-prevention regulations and general safety standards and regulations for the field of application of the device also apply. Illustrations in these instructions are provided to aid general understanding and might deviate from the actual model. No claims can be derived from any such differences.

Limitations of liability

All details and instructions in this manual have been compiled under consideration of the valid standards and regulations, the current state-of-technology and our many years of knowledge and experience. The manufacturer does not accept any liability arising from:

- non-observance of any details in these instructions
- improper use of the device, or use that is not in accordance with these instructions
- use of non-trained personnel

- unauthorized retrofitting or technical changes that have not been authorized by the manufacturer
- use of non-approved spare parts

The duties and obligations agreed upon in the delivery contract apply in full, as well as the general terms and conditions, the terms of delivery by the manufacturer and the valid legal regulations applicable at the conclusion of the contract.

Copyright

These operating instructions are protected by copyright.

Except for internal purposes, transfer of these instructions to third-parties, copying them in any way – even in part – as well as dissemination and/or communication of their content is forbidden without prior written authorization from Meister Strömungstechnik ("manufacturer"). Violations are subject to claims for indemnification. The manufacturer reserves the right to assert additional claims.

Copyright is the property of the manufacturer.

© Meister Strömungstechnik GmbH

Im Gewerbegebiet 2

63831 Wiesen

Germany

Table of contents

1	Overview	7
	1.1 Short description.....	7
	1.2 Warranty and guarantee provisions.....	7
	1.3 Customer service.....	7
2	Safety	8
	2.1 Explanation of symbols.....	8
	2.2 Correct use in accordance with these instructions.....	10
	2.3 Special precautions.....	11
	2.3.1 Hazards from electrical current.....	11
	2.3.2 Mechanical hazards.....	12
	2.3.3 Hazards from high or low temperatures.....	13
	2.3.4 Radiation hazards.....	13
	2.3.5 Hazards caused by media.....	14
	2.4 Personnel requirements.....	14
	2.5 Personal safety equipment.....	15
	2.6 Protective systems.....	16
	2.7 Replacement parts.....	16
	2.8 Environmental protection.....	17
	2.9 Responsibility of the owner.....	17
3	Design and function	20
	3.1 Overview.....	20
	3.2 Device description.....	20
	3.3 Component description.....	21
4	Transport, packaging and storage	22
	4.1 Safety instructions for transport.....	22
	4.2 Transport inspection.....	22
	4.3 Packaging.....	22
	4.4 Symbols on the shipping box.....	23
	4.5 Storage.....	23
5	Installation and initial startup	25
	5.1 Safety.....	25

5.2	Requirements at the place of installation.....	25
5.3	Preparatory work.....	26
5.4	Installation in the pipe line.....	30
5.5	Initial startup.....	34
5.6	Electrical connection.....	35
5.6.1	Connector DIN 43650.....	36
5.6.2	Plug connector M12x1.....	37
5.6.3	Cable.....	37
5.6.4	Degree of protection (IP-Code).....	38
5.7	Grounding the device.....	38
5.8	Plug connection.....	38
5.9	Contact protection measures.....	40
6	Operation.....	43
6.1	Switch point adjustment.....	43
6.2	Checking the flow.....	45
7	Troubleshooting.....	46
7.1	Safety.....	46
7.2	Troubleshooting guide.....	48
8	Maintenance.....	50
8.1	Safety.....	50
8.2	Maintenance plan.....	50
8.3	Removal from the pipe system.....	51
8.4	Disassembly.....	52
8.5	Maintenance.....	55
8.5.1	Cleaning.....	55
8.5.2	Parts replacement.....	56
8.5.3	Assembly.....	56
8.5.4	Switch contact replacement.....	59
8.6	Measures to be taken after maintenance work.....	61
9	Disassembly and disposal.....	62
9.1	Safety.....	62
9.2	Disassembly.....	62

9.3	Return Materials.....	63
9.3.1	Return Materials Authorization.....	63
9.4	Disposal.....	63
10	Technical data.....	64
10.1	Device data plate.....	64
10.2	Switch contact data plate.....	64
10.3	Dimension sheet.....	65
10.4	General specifications.....	66
10.5	Electrical specifications.....	66
10.6	Measuring ranges.....	68
10.6.1	Standard measuring ranges.....	68
10.7	Operating data.....	68
11	Appendix.....	69
11.1	Tightening torque.....	69
11.2	Replacement parts list.....	69
11.3	Tools.....	70
11.4	Sealant.....	70
11.5	Lubricants.....	71
12	Index.....	72

1 Overview

1.1 Short description

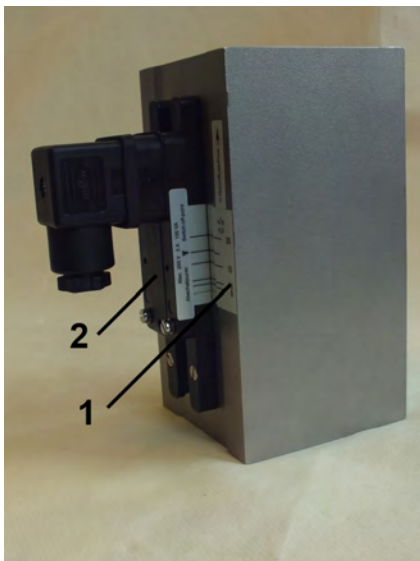

Fig. 1: WBMC flow monitor

- 1 Switch point adjustment scale
- 2 Switch contact with socket or cable

The WBMC flow monitor serves to monitor the continuous flow of liquids. It is designed for installation in pipe systems.

A float inside the device is moved by the medium flowing through it. The desired switch point can be set on the switch point adjustment scale, whereby the arrow on the switch contact is aligned to the desired volume flow value on the switch point adjustment scale.

External measuring devices can be connected at the socket.

1.2 Warranty and guarantee provisions

Warranty and guarantee provisions are contained in the general terms and conditions of the manufacturer.

1.3 Customer service

For technical information, please contact our customer service department (for contact details, see Page 2).

Furthermore, our staff is always interested in receiving new information and experiences gained from application of the device, which might be useful in improving our products.

2 Safety

This chapter provides an overview of important safety aspects required for optimum protection of personnel as well as for safe installation and safe operation of the device.

Non-observance of the handling and safety instructions listed in this manual may result in hazardous/dangerous conditions and in damage to property.

2.1 Explanation of symbols

Safety instructions

Safety instructions in this manual are marked by symbols. The safety instructions are preceded by signal words that indicate the level of danger/hazard.

To prevent accidents or injuries to persons as well as damage to property, always observe the safety instructions and proceed carefully.



DANGER!

This combination of symbol and signal word indicates an immediate, dangerous situation that results in death or serious injuries if it is not avoided.



WARNING!

This combination of symbol and signal word indicates a possibly dangerous situation that might result in death or serious injury if it is not avoided.



CAUTION!

This combination of symbol and signal word indicates a possibly dangerous situation that might result in minor or slight injuries if it is not avoided.



NOTICE!

This combination of symbol and signal word indicates a possibly dangerous situation that might result in damage to property and to the environment if it is not avoided.



Designates step-by-step handling instructions



Designates a state or an automatic sequence as a result of a specific operating step



Designates randomly ordered enumerations and list entries



“Signs used in these instructions” on page 9, designates references to chapters in these instructions

Tips and recommendations



This symbol emphasizes useful tips and recommendations as well as information for efficient and failure-free operation.

Signs used in these instructions

The following signs and highlighting are used in these instructions to identify handling instructions, the description of results, lists/enumerations, references and other elements:

2.2 Correct use in accordance with these instructions

The device is designed and constructed exclusively for the intended use described herein.

Correct use in non-hazard areas

The flow monitor serves exclusively to monitor the continuous flow of liquids within a temperature range of -20 °C to 100 °C (optional: 160 °C) at a maximum operating pressure of 180 bar (stainless steel version).

Correct use in explosion-hazard zones

For employment in explosion-hazard zones, changed conditions apply for the intended use.

The intended use in explosion-hazard zones is described in the Operating Instructions for "WBMC Module ATEX".

Intended use in explosion-hazard zones includes the observance of all specifications in these Operating Instructions, as well as those for "WBMC Module ATEX".

Any additional or different application, above or beyond the correct use in accordance with these instructions, is deemed as incorrect use.

WARNING!

Danger due to incorrect use!

Incorrect use of the flow monitor may result in dangerous conditions.

- Use the flow monitor only within the stipulated performance limits
- Do not subject the flow monitor to severe temperature fluctuations
- Do not use the flow monitor with quick-acting valves
- Do not use the flow monitor with solenoid valves
- Do not subject the flow monitor to vibrations
- Do not subject the flow monitor to pressure surges
- Do not use the flow monitor with media containing solids or abrasives
- Use the flow monitor only with media previously approved by the manufacturer
- Do not use the flow monitor as the sole monitoring device to prevent dangerous conditions
- Do not install the flow monitor as a load bearing part within a pipeline system
- The flow monitor must be installed so that it is protected from damage by outside force. If necessary, install an appropriate impact protection device.

All claims for damages due to incorrect use are excluded.

2.3 Special precautions

The following section lists residual risks that might arise from the device.

To reduce health risks and prevent dangerous conditions, observe the safety instructions listed here as well as the safety instructions in the other chapters of these operating instructions.

DANGER!

Employment of the device in explosion-hazard zones requires the observance of the Operating Instructions for "WBMC Module ATEX" including all hazard statements and warnings, therein.



These operating instructions cannot cover all conceivable dangers because many dangers arise, not from the device itself, but from the respective media flowing through it. Always observe the appropriate safety data sheets when using hazardous media!

2.3.1 Hazards from electrical current

Electrical current

DANGER!

Danger to life from electrical current!

There is an immediate risk to life from electrocution on touching live parts. Damaged electrical insulation or components can be extremely dangerous.

- Only qualified electricians shall work on the electrical system.
- If the insulation is damaged then immediately switch off and have repairs carried out.
- Before commencing work on live parts of the electrical systems and operating equipment, disconnect the equipment and ensure that it remains disconnected for the duration of the work. Observe these 5 safety rules when doing so:
 - Isolate (disconnect)
 - Secure against switching back on
 - Check for absence of voltage
 - Ground and short
 - Cover or cordon off other live parts in the vicinity

- Never bridge fuses or put them out of operation. Always observe the correct current ratings when replacing fuses
- Keep moisture away from live parts. This can result in short-circuit

2.3.2 Mechanical hazards

 **WARNING!**

Risk of injury due to fractured housing and leakage!

Unauthorized temperatures or excessive pressure may cause the flow monitor body or the process connections to burst. Injuries may be caused by flying debris and escaping media.

- Keep within the stipulated operating conditions
- Wear personal protective equipment
- Avoid severe temperature fluctuations
- Avoid pressure surges

 **CAUTION!**

Risk of injury on sharp edges and pointed corners!

Sharp edges and pointed corners can cause abrasions and skin cuts.

- Proceed with caution when working near sharp edges and pointed corners
- If in doubt, wear protective gloves

2.3.3 Hazards from high or low temperatures

Hot or cold surfaces

WARNING!

Risk of injury from hot or cold surfaces!

Surfaces of components may heat up/cool down dramatically due to the media flowing through them. Skin contact with hot or cold surfaces causes severe skin burning/freezing.

- Always wear temperature-resistant protective work clothing and protective gloves when working near hot/cold surfaces
- Before commencing any work, make sure that all surfaces have been cooled down or warmed up to ambient temperature

2.3.4 Radiation hazards

Strong magnetic fields

WARNING!

Danger to life from strong magnetic fields!

Strong magnetic fields may cause severe injuries or even be fatal, as well as cause considerable damage to property.

- Persons with pacemakers must not be located in the vicinity of the device. This could impair the function of the pacemaker
- Persons with metal implants must not be located in the vicinity of the device. Implants can heat up or be attracted magnetically
- Keep ferromagnetic materials and electromagnets away from the magnetic source. These materials could be attracted and fly through the room, thereby injuring or even killing persons. Minimum clearance: 3 m
- Remove and put away metal objects before maintenance work (jewelry, watches, writing implements, etc.)
- Do not place any electronic devices within the vicinity of the magnetic source. These could be damaged

- Do not place any electronic storage media, credit cards, etc. within the vicinity of the magnetic source. Data could be deleted

2.3.5 Hazards caused by media

Hazardous media



WARNING!

Risk of injury from hazardous media!

If the flow monitor is used for toxic, corrosive or very hot/cold media then there is a risk of serious injury if the media escapes.

- Observe details in the safety data sheet of the media
- Comply with the safety, accident prevention and environmental protection regulations appropriate to the media used
- Wear personal protective equipment in accordance with the safety data sheet

2.4 Personnel requirements



WARNING!

Risk of injury due to insufficiently trained and qualified personnel!

If unqualified personnel work on the device or are located within its hazard zone, dangers arise which may result in serious injuries and considerable damage to property.

- All work must be performed by qualified personnel only.
- Keep unqualified personnel away from hazard zones.

Authorized personnel is to be restricted to those persons who can be expected to carry out their work reliably. Persons whose ability to respond is influenced, e.g. by drugs, alcohol or medication, are not authorized.

Observe the age and occupational regulations at the site when choosing personnel.

The following lists the personnel qualifications for the various areas of activity:

Qualified electrician

Due to specialized training, knowledge and experience as well as knowledge of the relevant standards and regulations, the qualified electrician is able to independently perform work on the electrical systems as well as to detect and avoid possible risks and dangers.

Additionally, the electrician must provide proof of his/her professional qualification that certifies his/her ability to perform work on electrical systems.

The qualified electrician must fulfill the requirements contained in the valid legal accident-prevention regulations.

Qualified personnel

Due to their specialized training, knowledge and experience as well as their knowledge of the relevant standards and regulations, qualified personnel are able to independently carry out the work assigned to them as well as to detect and avoid possible risks and dangers.

2.5 Personal safety equipment

Personal safety equipment is used to protect personnel from hazards/dangers that might impair their safety or health during work.

When performing the various tasks at, and with the device, personnel must wear personal safety equipment. Special reference is made of this in the individual chapters within these Operating Instructions. The following provides a description of the personal safety equipment:

- Always wear appropriate personal safety equipment required in the various chapters of these Operating Instructions before commencing work.
- Comply with the personal safety equipment instructions posted within the work area.

Description of personal safety equipment

Goggles



The goggles are used to protect the eyes from flying debris and splashing fluid.

Protective gloves



Protective gloves protect the hands from friction, burns, grazing, abrasion, surface cuts or deeper injuries, as well as from direct contact with hot or cold surfaces.

With hazardous media, the protective equipment specified in the Safety Data Sheet of the medium must be worn. In addition, the specifications of the system operator must be followed. If no protective equipment is specified, suitable protective gloves and goggles must be worn.

The protective equipment is used to protect against hazardous media leaks and hazardous media residue in the device.

2.6 Protective systems

Integration within an emergency-stop concept is required

The device is designed for use as a part of a machine or system. It does not have its own controller and does not have an autonomous emergency-stop function.

Before starting up the device, install the emergency-stop equipment and incorporate it into the safety chain of the machine or system.

Connect the emergency-stop equipment so that if there is an interruption in the power supply or in the activation of the power supply after an interruption, dangerous conditions are excluded for persons and valuables.

The emergency-stop equipment must always be freely accessible.

2.7 Replacement parts



WARNING!

Risk of injury due to use of incorrect replacement parts!

Use of incorrect or faulty replacement parts may result in dangers to personnel as well as damages, malfunctions or total failure.

- Only use original replacement parts from the manufacturer or approved by the manufacturer.
- Always contact the manufacturer in case of doubt.

Always purchase replacement parts from an authorized dealer or directly from the manufacturer (For contact details, see Page 2).

The replacement parts list is in the annex.

2.8 Environmental protection

! NOTICE!

Risk to the environment due to improper handling of environmentally hazardous substances!

Serious environmental damage can result if substances harmful to the environment are handled incorrectly, especially if they are disposed of improperly.

- Always observe the instructions listed below on the handling and disposal of substances harmful to the environment.
- If harmful substances are released into the environment, take immediate countermeasures. If there is doubt, contact the local authorities, inform them of the damage and request information on suitable countermeasures to be taken.

Cleaning fluids

Solvent-based cleaning fluids contain toxic substances. They must never be released into the environment and must be disposed of by a waste management company.

Lubricants

Lubricants such as greases and oils contain toxic substances. They must never be released into the environment and must be disposed of by a waste management company.

2.9 Responsibility of the owner

Owner

The owner is the person who operates the device himself for business or commercial purposes or who cedes such use/application to a third-party and who, during operation of the device, has full legal product stewardship for protection of the user, the personnel or third-parties.

Duties of the owner

The device is used in the commercial sector. The owner of the device is therefore subject to legal obligations pertaining to work safety.

In addition to the safety instructions contained in these Operating Instructions, the safety, accident prevention and environmental protection regulations applicable to the field of application of the device must be observed.

In particular, this includes:

- The owner must inform himself regarding the valid health and safety regulations and must carry out a risk assessment to additionally determine the risks resulting from the special work conditions arising at the location at which the device is used, especially in regard to the media used. He must then implement these within Operating Instructions for use of the device.
- The "Occupational Health and Safety Act" of 1970 stipulates that it is the duty of the owner to provide a safe workplace. He must hereby ensure that the device is operated and maintained compliant to valid commercial, industrial, local, federal and state laws, standards and regulations.
- Appropriate to the working conditions and the media used, the owner must affix signs within the working area that inform the user of the hazards and dangers present.
- During the entire period of use of the device, the owner must check periodically to ensure that the Operating Instructions correspond to the current state of regulations, and he must make adjustments as necessary.

- The owner must clearly regulate and determine responsibilities for installation, operation, trouble-shooting, maintenance and cleaning.
- The owner must fit/retrofit suitable safety equipment within the complete plant/system.
- The owner must ensure that all staff/personnel have thoroughly read and understand these instructions before handling the device. Additionally, he must train the personnel at regular intervals and warn them of dangers.
- The owner must provide the personnel with the required safety equipment and must instruct them that its wear is mandatory.

Additionally, the owner is responsible for ensuring that the device is always kept in a technically perfect condition. The following therefore applies:

- The owner must implement suitable safety measures, appropriate to the media used.
- Different media have different severities of influence on the soiling and wear of/to the device. The owner must set suitable maintenance intervals, depending on the media flowing through the device.

- The owner must ensure that the maintenance intervals described in these Operating Instructions are adhered to at all times.
- The owner must ensure that the device is completely free of all residual media before disposal. Remains of corrosive or toxic materials must be neutralized.

3 Design and function

3.1 Overview

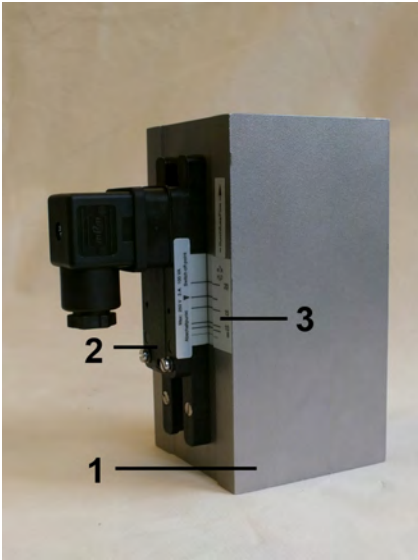

Fig. 2: Overview

- 1 Device body
- 2 Switch contact and female socket or switch contact with cable
- 3 Switchpoint adjustment scale

3.2 Device description

WBMC flow monitors operate on the functional principle of the variable area flow meter. The flow monitor is installed into a pipe system and measures the flow rate of the medium flowing through the pipe system.

A float inside the flow monitor is moved by the flowing medium. A magnetic field is generated by the magnets inside the float. The position of the float is detected by the switch contact. The desired switch point can be set on the switch point adjustment scale by moving the switch contact.

Applications for WBMC flow monitors are, for example, cooling circuits. The device monitors the volume flow of the cooling media to ensure sufficient cooling. If the flow drops below the threshold set by the operator, the switch contact switches (Change-Over Contact) or opens (Normally Open Contact).

3.3 Component description

Switch contact

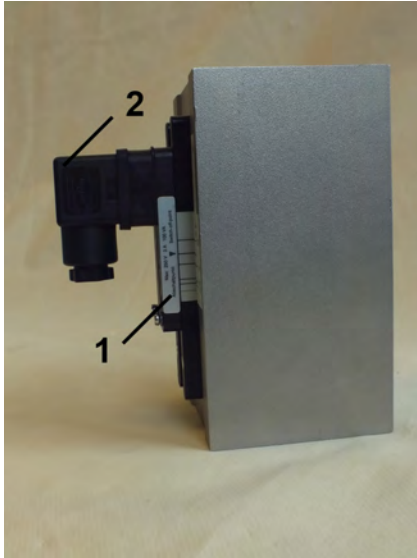

Fig. 3: Switch contact and socket

A potential-free Reed contact is cast into the switch contact (Fig. 3/1). The device is equipped with a connector (Fig. 3/2).

Switch point adjustment scale



Fig. 4: Switch point adjustment scale (example)

A scale is applied to the device body, to which the desired switch point can be adjusted.

4 Transport, packaging and storage

4.1 Safety instructions for transport

Improper transport

NOTICE!

The device could be damaged if transported improperly!

Objects to be transported may fall or overturn if transported incorrectly. This can result in damage to the device and/or property.

- Proceed carefully when unloading transported packages, both on delivery and when transporting in-house. Observe the symbols and instructions on the shipping box
- Only remove packaging immediately before assembly

4.2 Transport inspection

On delivery, make an immediate check for completeness and check for transport damages.

If there are any visible external transport damages then proceed as follows:

- Do not accept the delivery
- Note the damage in the shipping documents or on the delivery note of the transporter and have the driver confirm by signature
- Initiate a claim for damages



Make a claim for each fault as soon as it is detected. Claims for damages can only be invoked within the valid claim periods.

4.3 Packaging

About packaging

The packaging serves to protect the individual components from transport damages, corrosion and other damages until they are installed. Do not discard the packaging and only remove the device from the shipping box immediately before installation.

Handling packaging materials

Dispose of packaging material in accordance with the valid legal regulations and local ordinances.

! NOTICE!

Danger to the environment due to incorrect disposal!

Packaging is made of valuable raw materials and can be reused in many cases or usefully processed and recycled. Improper disposal of packaging materials may pose a danger to the environment.

- Dispose of packaging material in an environmentally safe manner
- Comply with the local disposal regulations. If necessary, have the packaging disposed of by approved specialists.

4.4 Symbols on the shipping box

Top



The arrowheads indicate the top side of the package. They must always point upwards, otherwise the content may be damaged.

Fragile



Designates packages with breakable or damageable contents.

Handle the package carefully and do not allow it to fall or be subjected to jarring or severe vibration.

4.5 Storage

Storing the packages

Store the packages under the following conditions:

- Do not store in the open
- Store dry and dust-free
- Do not subject to any aggressive media
- Protect from direct sunlight
- Avoid mechanical vibrations and shocks
- Storage temperature: 0 to 35 °C
- Relative humidity: max. 60 %
- Do not stack
- If storing for longer than 3 months, regularly check the general condition of all parts as well as of the packaging.



Storage instructions in addition to the instructions listed here may be listed on the packages. Follow these instructions also.

5 Installation and initial startup

5.1 Safety

Incorrect installation and initial startup

 **WARNING!**

Risk of injury due to incorrect installation and initial startup!

Incorrect installation and initial startup may result in severe injuries and considerable damage to property.

- Ensure that the site is sufficiently cleared of obstructions before commencing work
- Handle open or sharp edged components carefully
- Ensure that the assembly location is orderly and clean! Parts and tools lying about or on top of each other are potential causes of accidents
- Assemble components properly. Observe the stipulated tightening torque of screws
- Before initial startup, make sure that all installation work has been carried out and completed in compliance with the specifications and instructions in these Operating Instructions

Safeguard against restart

 **WARNING!**

Danger to life due to unauthorized restart!

There is a risk of severe or even fatal injuries from unauthorized restart of the power supply during installation.

- Before commencing work, switch off the power supply to the entire system/plant and secure against restart

5.2 Requirements at the place of installation

The place of installation must meet the following requirements

- The device must not be under water.
- The surrounding area must be sufficiently illuminated.
- There must be sufficient space to prevent accumulation of trapped heat.
- The device must not be installed as a supporting part in a pipe construction.
- The device may not have anything affixed to, or suspended from it.

- The flow monitor must be installed in such a way as to preclude damage by outside force. It must be ensured that the flow monitor cannot be damaged. If necessary, install an appropriate impact protection device.
- External magnetic fields will influence the switch contact. Keep sufficient distance to magnetic fields (e.g. electric motors).
- Piping, process connections or supports made from ferromagnetic material influence the magnetic field of the device. Keep a space of minimum 100mm to those materials (e.g. steel).

 **WARNING!**

Danger due to incorrect installation!

If the requirements are not met when installing the flow monitor, dangerous/hazardous conditions may arise.

- Do not install the flow monitor as a supporting part in a pipe system
- Do not use the flow monitor with quick-acting valves
- Do not use the flow monitor with solenoid valves

5.3 Preparatory work

To ensure proper functioning of the flow monitor, the following requirements must be met during installation:

Installation position/direction of flow

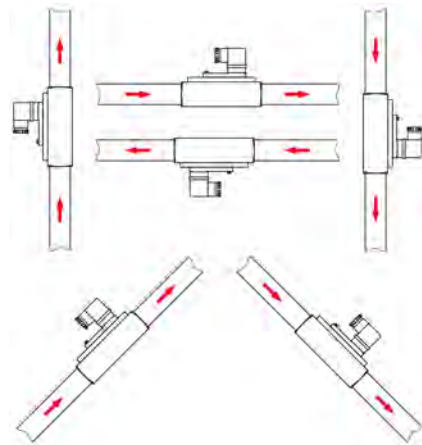

Fig. 5: Installation position/direction of flow

Install the flow monitor only in one of the positions displayed above. The medium must flow in the direction of the arrow (from a low to a high scale value).

Unimpeded flow sections

! NOTICE!

Measuring inaccuracy due to incorrect installation!

The measuring accuracy of the flow monitor is influenced by its position within the pipe system. Changes in cross-section, branch-offs or bends in the pipe line system impair measuring accuracy.

- Ensure that the unimpeded flow sections are maintained
- Never reduce the pipe diameter immediately before the device

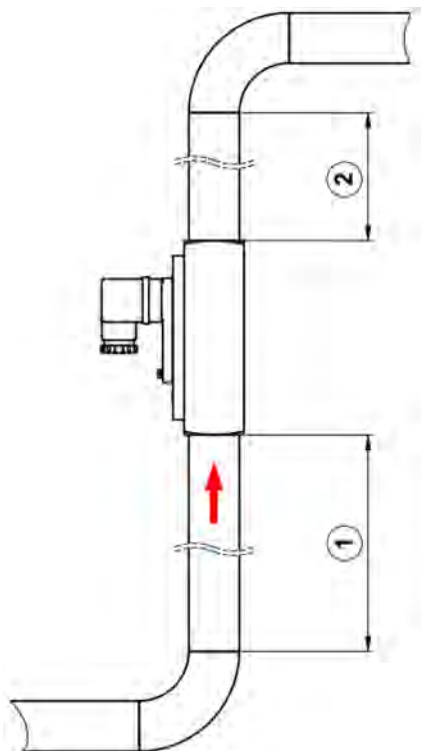

Fig. 6: Unimpeded flow sections

- 1 10x DN
- 2 5x DN

- An unimpeded flow section of 10xDN (rated width) must be maintained before the device.
- An unimpeded flow section of 5xDN (rated width) must be maintained after the device.

Unimpeded outlet

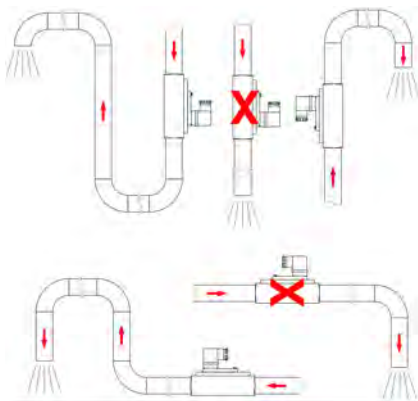

Fig. 7: Unimpeded outlet

If the pipe line ends at an unimpeded outlet, the flow monitor must not be installed directly in front of the opening. The device must always be completely filled with media to ensure measuring accuracy.

Strainer

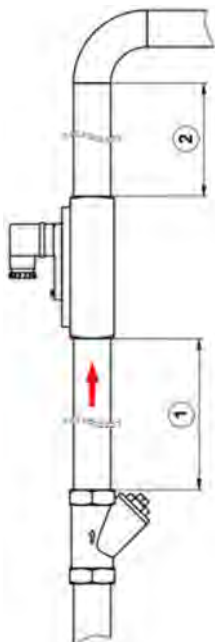



Fig. 8: Strainer

- 1 min. 10x DN
- 2 min. 5x DN

If the medium is contaminated by solids, a strainer must be installed before the device ( “Strainer” on page 29).



We recommend a Type SF, SFD or SFM strainer.

Prepare the device

NOTICE!



Risk of damage to property due to contamination!

Contamination and deposits may impair the free movement of the float, thereby damaging the device.

- Ensure that there are no foreign particles in the device
- Ensure that the device is not soiled
- Do not use any medium containing solids



Due to quality assurance measures, there may be some test medium (water) residue in the device.

1.  Unpack the device and visually inspect the device to ensure that it is free of packaging materials
2.  Examine the device for residue of test medium and drain, if necessary
3.  Check the device for soiling and flush with clean medium, if necessary

5.4 Installation in the pipe line



WARNING!

Risk of injury from pressurized lines!

If the pipe system is under pressure when installing the device, severe injuries may result.

- Depressurize the pipe system before installing the device



WARNING!

Risk of injury from hot or cold surfaces!

Pipe lines can heat up/cool down dramatically due to the media flowing through them. Skin contact with hot or cold surfaces may cause severe skin burn or frost bite.

- Before commencing work, ensure that the system has been controlled to a temperature range between 0 and 40 °C.
- Do not touch any parts of the system that are either very hot or very cold.
- Always wear heat-resistant/cold-resistant protective clothing and protective gloves when working near hot/cold surfaces.



WARNING!

Risk of injury from media in the pipe system!

If the pipe system contains hazardous media, severe injuries may be caused by escaping media.

- Before installation, ensure that the pipe system is empty and does not contain any media residue
- Always wear personal protective equipment during installation
- Provide suitable draining devices (collection tanks, etc.)



A suitable sealant must be selected depending on the condition/composition of the pipe lines, the medium and the operating and environmental conditions. The sealing method described here is only an example and cannot be used in all cases.



NOTICE!

Risk of damage to the device due to contamination in the pipe system!

Dirt and foreign particles entering the device can damage the device and impair its operation.

- Ensure that the pipe system is clean before installing the device
- If necessary, flush the pipe system with clean medium before installation

Sealing the pipe connections

Personnel:

- Qualified personnel

1. Nap the thread

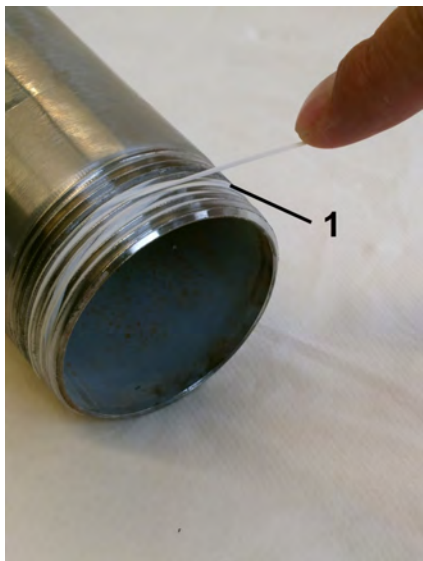

Fig. 9: Apply sealing thread

- #### 2. Apply sealing thread (Fig. 9/1) to the napped area in the threaded direction. Observe the quantity recommended by the sealant manufacturer.



Fig. 10: Pipe connection with sealing thread

- ⇒ The pipe line is now ready for installation (Fig. 10)

Install device in pipe system

Personnel:

- Qualified personnel

Protective equipment:

- Protective gloves

Tools:

- Fixed spanner
- Pipe wrench



CAUTION!

Do not hold the device by its threads. These are sharp edged and may cause injury.

1. ➤ Start the threaded end of the device onto the thread of the connecting pipe.

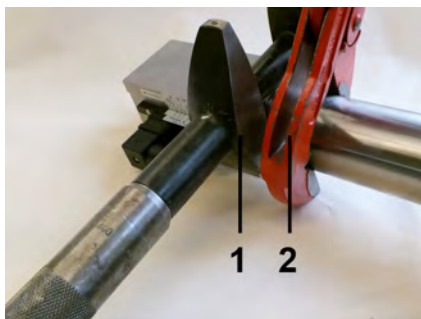

Fig. 11: Screw in the device

2. ➤ Using the pipe wrench, (Fig. 11/2) screw the pipe line into the device. When doing so, lock the device body in place to prevent slip, using a suitable spanner (Fig. 11/1).

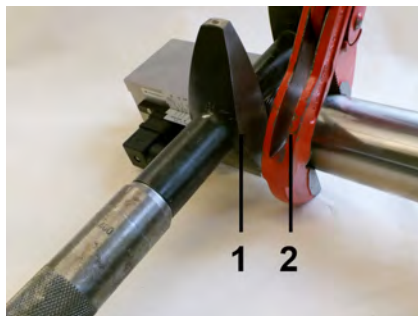

Fig. 12: Screw in the device

3. ➤ Continue to screw in the pipe line, (Fig. 12/2) while holding the device body in place (Fig. 12/1) until the connection is tight.
4. ➤ Repeat these steps at the other end of the device.

5.5 Initial startup

The following steps must be taken before initial startup and any subsequent startup (e.g. after removal and installation during maintenance).

1. →



WARNING!

Make sure that the plant is operating vibration-free. Vibrations could destroy the device. This could result in a serious risk of injury to the user.

2. →



WARNING!

Make sure that the medium is flowing continuously. Pulse-like staggered loads could destroy the device. This could result in a serious risk of injury to the user.

3. →



NOTICE!

Completely fill the pipe lines. Partial filling(s) may result in malfunctions and damage to the device.

4. →



NOTICE!

Vent the pipe line. If there are air bubbles in the line during the measurement then this could result in damage to the device caused by hydraulic shock. This could result in malfunctions.

5. →



NOTICE!

Make sure that the plant is operating without cavitation. Cavitation may result in malfunctions and damage to the device.

5.6 Electrical connection

The electrical connection of the flow monitor is accomplished through the connector plug or the cast on power cable leading from the switch housing. The switch contacts employed in these devices are potential free and do not require a power source. Switch contacts and flow monitor have been optimally harmonized. After replacement of a switch contact, the switch point must be readjusted.



DANGER!

Danger to life from electrical current

There is an immediate risk to life from electrocution on touching live parts. Damage to the electrical insulation or single components can be extremely dangerous.

- Only qualified electricians shall work on the electrical system
- If the insulation is damaged then immediately switch off and have repairs carried out
- Before commencing work on live parts of electrical systems and components, disconnect the equipment and ensure that it remains disconnected for the duration of the work. Observe these 5 safety rules when doing so:
 - Isolate (disconnect)

- Secure against switching back on
- Check for absence of voltage
- Ground and short
- Cover or cordon off other live parts in the vicinity
- Never bridge fuses or put them out of operation. Always observe the correct current ratings when replacing fuses
- Keep moisture away from live parts. This can result in short-circuit

5.6.1 Connector DIN 43650

Wiring diagram of the supplied socket (DIN 43650, Form A) (Front view).

Wiring diagram normally open:

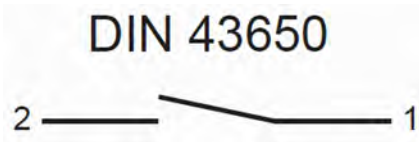

Fig. 13: Switch position under no-flow condition

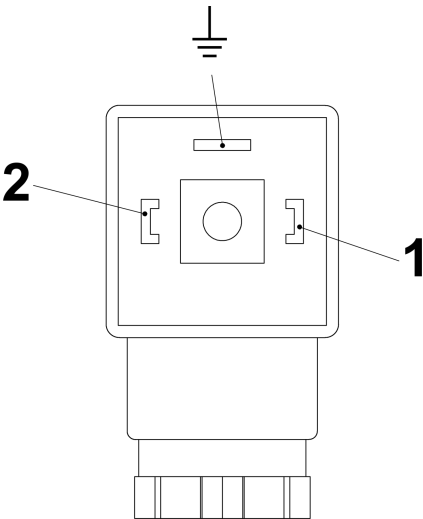

Fig. 14: Pin assignment, plug socket, normally-open contact. The ground-pin is not used.

change over:



Fig. 15: Switch position under no-flow condition

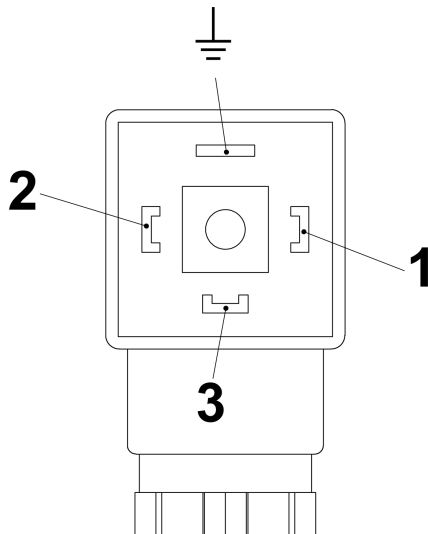

Fig. 16: Pin assignment, plug socket, change-over contact. The ground-pin is not used.

5.6.2 Plug connector M12x1

Wiring diagram, socket (M12x1)

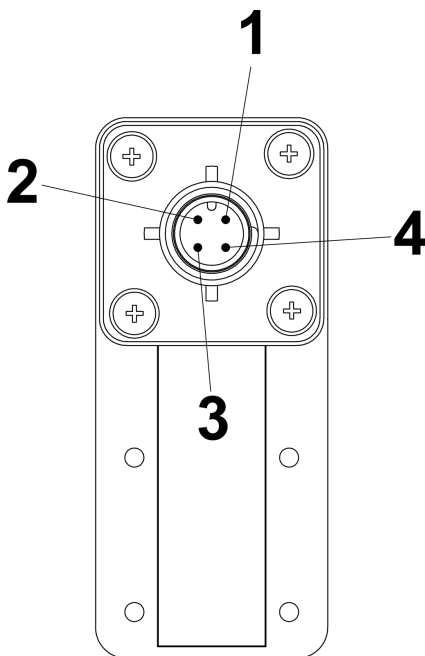

Fig. 17: Pin-assignment, socket M12x1 Form 30x70)

Wiring diagram

normally open:

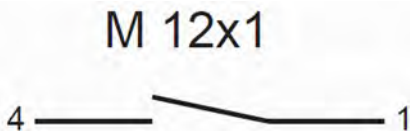

Fig. 18: Switch position under no-flow condition

change over:

M 12x1



Fig. 19: Switch position under no-flow condition

5.6.3 Cable

The individual cores of the cable are numbered according to the following connection diagrams.

Wiring diagram

normally open:

Cable



Fig. 20: Switch position under no-flow condition

change over:

Cable



Fig. 21: Switch position under no-flow condition

5.6.4 Degree of protection (IP-Code)

The specified degree of protection (IP) is only ensured if approved connection material is used (see following table).

Device connection	Specification of connection material	Degree of protection
DIN 43650 with gland	Diameter of connection cable: 6–8 mm	IP65
M12x1	Plug connector M12x1	IP67
Cable	-	IP67

5.7 Grounding the device

When installing the device in a pipe system, ensure that the device is grounded to the pipe system to avoid a dangerous electrical potential difference.

5.8 Plug connection

Personnel:

- Qualified electrician

Tools:

- Flat-bladed screwdriver

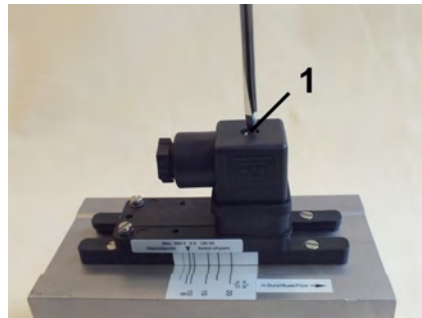

Fig. 22: Detach socket

1. Release the fixing screw (Fig. 22/1)

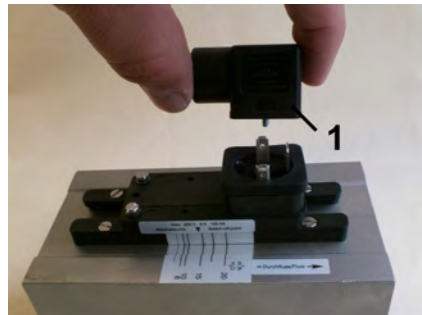

Fig. 23: Remove socket

2. Remove socket (Fig. 23/1).



Fig. 24: Loosen inner section

3. ➤ Remove the inner section from the socket by inserting a flat-bladed screwdriver into the slot (Fig. 24/1) and carefully pry out the inner section.



Fig. 25: Loosen the screw connection

4. ➤ Unscrew the screw connection (Fig. 25/1) by turning in the direction of the arrow
5. ➤ Guide the connecting cable through the screw connection into the socket
6. ➤ Make the connections as shown in the connecting diagram (Fig. 26 und Fig. 27)
7. ➤ Place the inner section (Fig. 24) back into the socket and push until it locks on
8. ➤ Tighten the screw connection (Fig. 25/1) by turning it to the right until tight

9. → Place the female socket onto the connecting plug and tighten the fixing screw (Fig. 22/1)

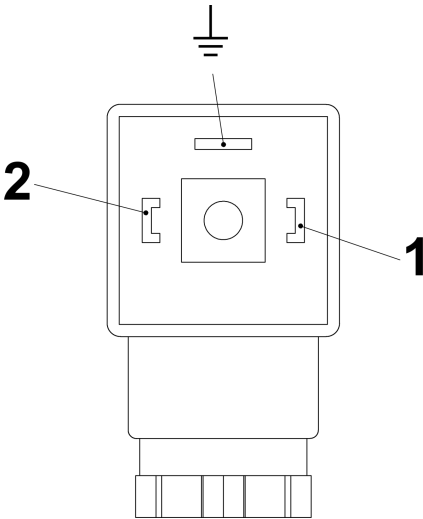

Fig. 26: Pin assignment, plug socket, Normally Open Contact (Form 30x70)

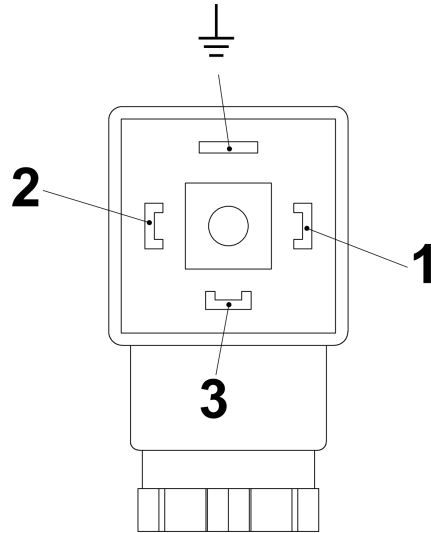

Fig. 27: Pin assignment, plug socket, Change-over contact (Form 30x70)

5.9 Contact protection measures

The Reed-switches used in the switch contacts are designed to be very sensitive to overload. To prevent destruction of the switch contact, the values specified on the rating plate of the switch contact housing must never be exceeded (not even temporarily).

There is a risk of overload from:

- inductive loads
- capacitive loads
- ohmic loads.

Suitable measures must be taken to protect against overload (see following examples):

Inductive load

There is danger of voltage peaks from inductive loads when switching off (up to 10 times the rated voltage). Inductive loads are caused by, e.g.:

- Contactors, relays
- Solenoid valves
- Electric motors

Examples of protective measures:



Fig. 28: Example 1

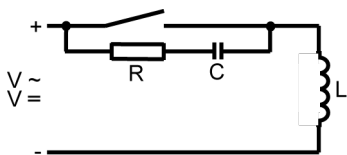

Fig. 29: Example 2

Capacitive loads

There is a danger of high current peaks from capacitive loads when switching-on the switch contact (exceeding rated current). Capacitive loads are caused by, e.g.:

- Long connecting cables
- Capacitive consumers

Example of protective measure:

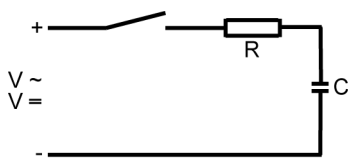

Fig. 30: Protective measure against capacitive loads

Ohmic loads

There is a danger of high current peaks from ohmic loads when switching-on the switch contact. The reason for this is that the glow filament has a low resistance at low temperatures. Ohmic loads are caused by, e.g.:

- Filament bulbs
- Motors during startup

Examples of protective measures:

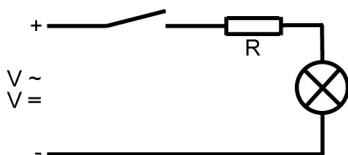

Fig. 31: Example 1

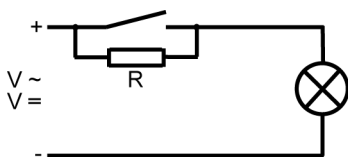

Fig. 32: Example 2

Protection against ohmic loads can be achieved through installation of a resistor in the circuit, or by heating the glow filament. For connection to high-impedance consumers (ex. PLC), a protective circuit is not needed.

6 Operation

6.1 Switch point adjustment

Setting the switch point of an installed device



The following instructions describe the procedure for a Normally Open Contact (NOC). The actual state (open or closed), can be determined using a continuity meter.

Personnel:

- Qualified personnel

Tools:

- Flat-bladed screwdriver

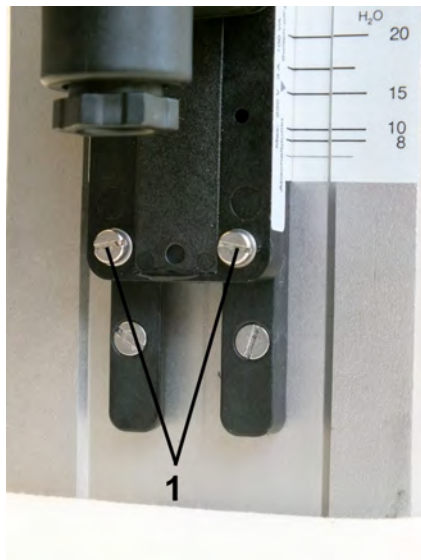

Fig. 33: Loosen set screws

1. Loosen the set screws of the switch contact (Fig. 33/1) using a flat-bladed screwdriver.
2. Set the switch contact to the flow value to be monitored. Make sure that the arrow on the switch contact data plate is exactly in alignment with the desired flow rate on the switch point adjustment scale.
3. Tighten the set screws of the switch contact (Fig. 33/1) using a flat-bladed screwdriver. When doing so, observe the correct tightening torque of the screws.

☞ Chapter 11.1 "Tightening torque" on page 69

- ⇒ The set switch point corresponds to the switch-off point of the switch contact by decreasing flow.

Setting the switch point of a non-installed device

- ⇒ The set switch point corresponds to the switch-off point of the switch contact by decreasing flow.

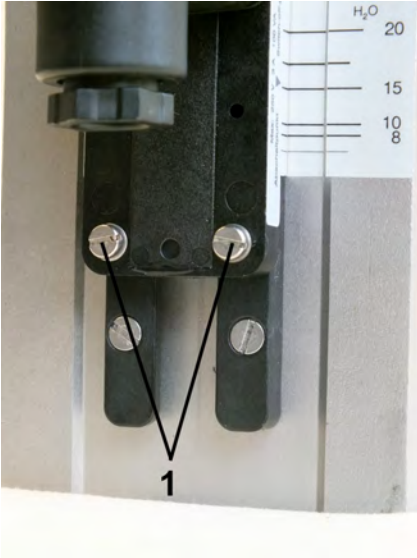

Fig. 34: Loosen set screws

1. ➤ Loosen the switch contact set screws (Fig. 34/1) using a flat-bladed screwdriver.
2. ➤ Slide the switch contact to the flow value to be monitored. Make sure that the arrow on the switch contact label is in exact alignment with the desired flow value on the scale on the device body.
3. ➤ Re-tighten the switch contact set screws (Fig. 34/1) using a flat-bladed screwdriver. Observe the correct tightening torque

🔗 Chapter 11.1 "Tightening torque" on page 69

6.2 Checking the flow

Reading-off the switch value

Personnel:

- Qualified personnel

Protective equipment:

- Goggles



3.  Read-off the switch value from the switch point adjustment scale.



Fig. 35: Reading-off the switch point (example)

1.  Make sure that the setting arrow, the scale mark on the additional label on the guide rail and the scale mark of the switchpoint adjustment scale are in alignment. (Fig. 35).
2.  To obtain the greatest reading accuracy, read-off straight-on. The read-off value can be falsified by viewing at an angle from above or below (parallax error).

7 Troubleshooting

This chapter describes possible malfunctions of the device, their causes and repair.

If malfunctions persist or increase, shorten the maintenance interval to meet the actual operating conditions.

For malfunctions not described in this chapter, please contact the manufacturer (see service address on page 2).

7.1 Safety

Work carried out incorrectly to remedy a malfunction



WARNING!

Risk of injury due to incorrect repair of malfunction!

Work carried out incorrectly may result in severe injuries and considerable damage to property.

- Ensure that the site is sufficiently cleared before commencing work
- Ensure that the repair location is orderly and clean! Components and tools that are lying about or on top of each other are potential causes of accidents
- If components have been removed, observe correct assembly procedures. Reinstall all fixing/fastening elements and observe the prescribed tightening torque for the screws
- Before placing the device back into operation, ensure that all work has been carried out and completed in compliance with the specifications and instructions in these Operating Instructions

Conduct in case of malfunction

The complete machine or system may be unsafe if there is a defect at the flow monitor (e.g. fractured housing).

The following always applies:

- 1.** ▶ In case of malfunctions that present an immediate danger to persons or valuables, proceed according to the valid emergency plans for the system
- 2.** ▶ Determine the cause of the malfunction
- 3.** ▶ Before repair, ensure that there is no danger to persons from escaping media
- 4.** ▶ If necessary, allow the pipeline and device to cool down or to warm up before commencing work
- 5.** ▶ Malfunctions must be corrected by qualified personnel



The following troubleshooting guide provides an indication of who is qualified to repair the fault .

7.2 Troubleshooting guide

Fault description	Cause	Remedy	Personnel
The switch contact does not switch.	No medium flowing through flow monitor	Check that medium is flowing through the pipe-line	Qualified personnel
	Flow is too low or the switch contact is set too high	<ul style="list-style-type: none"> ■ Adjust the switch contact to a lower flow rate ■ Use the device at another measuring range ■ Increase the flow rate 	Qualified personnel
	Incorrect reduction fitting or pipe diameter is too small	<ul style="list-style-type: none"> ■ Correct pipe diameter 	Qualified personnel
	Float is stuck	Disassemble and clean the device	Qualified personnel
	Switch contact is defective.	<ul style="list-style-type: none"> ■ Remedy the cause of the defect (short-circuit, overload) ■ Replace the switch contact 	Qualified personnel
Switch contact is permanently switched.	Flow is too high or the switch contact is set too low	<ul style="list-style-type: none"> ■ Reduce the flow ■ Adjust the switch contact to a higher flow rate ■ Use the device at another measuring range 	Qualified personnel

Fault description	Cause	Remedy	Personnel
	Float is stuck	Disassemble and clean the device	Qualified personnel
	Switch contact is defective	<ul style="list-style-type: none"> ■ Remedy the cause of the defect (short-circuit, overload) ■ Replace the switch contact 	Qualified personnel
The switch point is not the same as the actual flow rate.	Improper scale installed for media used	Request proper conversion table or scale for media used	Qualified personnel
	Incorrect reduction fitting or pipe diameter is too small	<ul style="list-style-type: none"> ■ Correct pipe diameter 	Qualified personnel
	Device is dirty	Disassemble and clean the device	Qualified personnel
	Device is defective	Remove device from system and contact the manufacturer	Qualified personnel

8 Maintenance

8.1 Safety

Maintenance work performed incorrectly



WARNING!

Risk of injury due to maintenance work performed incorrectly!

Maintenance work performed incorrectly may result in severe injuries and considerable damage to property.

- Ensure that the site is sufficiently cleared before commencing work.
- Ensure that the repair location is orderly and clean! Components and tools that are lying about or on top of each other are potential causes of accidents.
- If components have been removed, observe correct assembly procedure. Reinstall all fixing/fastening elements and observe the prescribed tightening torque for the screws (see Chapter 11.1).
- Before placing the device back into operation ensure that all work has been carried out and completed in compliance with the specifications and instructions in these Operating Instructions.

8.2 Maintenance plan

Intervals for replacement of wear parts

WBMC type flow monitors require very little maintenance due to the small number of moving parts. The intervals for the replacement of wear parts depends significantly on the operating conditions as well as on the composition of the medium flowing through the device. For this reason, no intervals have been set by the manufacturer. The operator must determine suitable intervals based on the local condition and circumstances.

Interval	Maintenance work	Personnel
	Visual inspection for dirt/soiling	Qualified personnel
	Visual inspection for free-movement of float	Qualified personnel
	Visual inspection for leaks from the device	Qualified personnel
	Check function of switch contact	Qualified personnel

8.3 Removal from the pipe system

The flow monitor must first be removed from the pipe system before performing maintenance.



WARNING!

Risk of injury from pressurized lines!

Severe injuries may result if the pipe system is under pressure when removing the device.

- Depressurize the system before removing the device



WARNING!

Risk of injury from hot or cold surfaces!

Pipelines can heat up/cool down dramatically due to the media flowing through them. Skin contact with hot or cold surfaces causes severe skin burns or frost bite.

- Before removing the device, ensure that the machine or system and the flow monitor have been controlled to a temperature range between 0 and 40°C
- Do not touch any part of the machine or system that is either very hot or very cold
- Always wear heat-resistant/cold-resistant protective work clothing and protective gloves when working near hot/cold surfaces

**WARNING!****Risk of injury from media in the pipe system!**

If the pipe system contains hazardous media, severe injuries may be caused by escaping media.

- Before removing the device, ensure that the pipe system is empty and does not contain media residue
- Always wear personal protective equipment when removing the device

**WARNING!****Risk of injury from media residue in the device!**

After the pipe system has been emptied, media residue can still be present inside the device. In the case of hazardous media, this could result in serious injuries.

- When removing (de-installing the device from the pipe system), always wear personal protective equipment.
- All requirements specified in the media safety data sheet must be observed in accomplishing the work task.
- Residue of hazardous media in the device can result in serious injuries.

Removing the device from the pipe system**Personnel:**

- Qualified personnel

Protective equipment:

- With hazardous media, the protective equipment specified in the Safety Data Sheet of the medium must be worn. In addition, the specifications of the system operator must be followed. If no protective equipment is specified, suitable protective gloves and goggles must be worn.

Tools:

- Fixed spanner

1. ▶ Loosen the adapter union of the pipe line using a suitable spanner. When doing so, lock the process connection or device body in place with a second spanner.
2. ▶ Secure the device against falling and repeat Step 1 at the other process connection.

8.4 Disassembly

To replace wear parts or to clean the device, the flow monitor must first be disassembled.



WARNING!

Risk of injury due to incorrect disassembly!

- The device may still contain media residue
- Wear personal protective equipment when working with dangerous media
- Improper disassembly may cause serious injuries if dangerous media is still present inside the device



CAUTION!

Risk of injury due to improper disassembly!

Improper disassembly may result in injuries.

- Before disassembling, ensure that the flow monitor has cooled down/warmed up to a temperature range between 0 and 40 °C
- Wear personal protective equipment to protect against hazardous media which may still be present inside the device.

Protective equipment:

- With hazardous media, the protective equipment specified in the Safety Data Sheet of the medium must be worn. In addition, the specifications of the system operator must be followed. If no protective equipment is specified, suitable protective gloves and goggles must be worn.

Personnel:

- Qualified personnel

Protective equipment:

- Goggles
- Protective gloves

Tools:

- Snap ring pliers



Fig. 36: Loosen snap ring (inlet)

1. ➤ Insert the snap ring pliers into the device inlet and loosen the snap ring (Fig. 36)



Fig. 37: Remove snap ring

2. ➤ Remove the snap ring from the device body (inlet) (Fig. 37)



Fig. 38: Remove inner parts

3. ➤ Carefully rotate the device body 180° and remove the inner parts (float, magnets and spring) (Fig. 38)

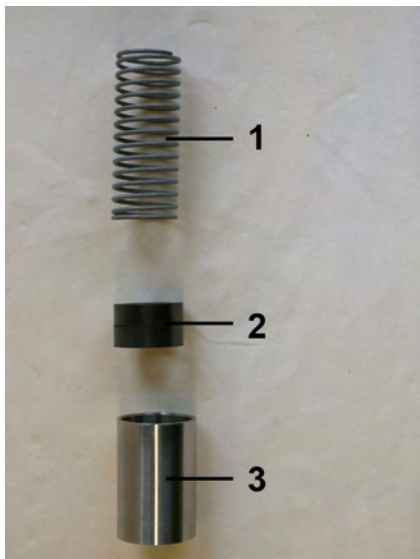



Fig. 39: Spring, magnets and float

4.  The inner parts of the flow monitor consist of the spring (Fig. 39/1), magnets (Fig. 39/2) and float (Fig. 39/3)

8.5 Maintenance

8.5.1 Cleaning

It is the responsibility of the operator to establish appropriate intervals and procedures for cleaning the individual parts of the device. It must be ensured that the parts are not damaged during the cleaning process. When using

cleaning agents, it must be ensured that these are not aggressive to the parts and that there will be no dangerous reactions with media residue. Damaged parts must be replaced.

WARNING!

Risk of injury due to improper cleaning!

The device may still contain media residue.

- To protect against hazardous media residue in the device, wear personal protective equipment.
- Do not use cleaning agents which may lead to dangerous reactions with media residue.
- All requirements specified in the safety data sheet must be observed when handling or otherwise using the medium.
- Residue of hazardous media inside the device can cause serious injury.

**CAUTION!****Risk of injury due to damaged parts!**

If parts of the device are broken or damaged, they may cause injury due to sharp edges or splinters during the cleaning process.

- Damaged parts must be replaced
- Carefully clean the parts of the device, so as not to cause damage
- When cleaning, always wear appropriate personal protective equipment
- Incorrect disassembly can result in injuries

Protective equipment:

- With hazardous media, the protective equipment specified in the Safety Data Sheet of the medium must be worn. In addition, the specifications of the system operator must be followed. If no protective equipment is specified, suitable protective gloves and goggles must be worn.

8.5.2 Parts replacement

Depending on the operating conditions, wear parts such as float or magnets may have to be replaced. Steps required to replace these parts correspond to those used when assembling the device. ↪ *Chapter 8.5.3 “Assembly” on page 56.*

8.5.3 Assembly

After cleaning the individual components, the flow monitor must be reassembled.

Personnel:

- Qualified personnel

Tools:

- Snap ring pliers

Special tools:

- Test rod
- Magnetic pole indicator

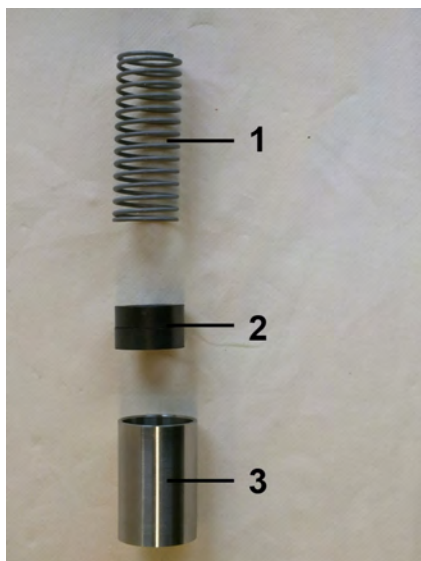

Fig. 40: Inner parts

1. ➤ Insert spring (Fig. 40/1) with magnets (Fig. 40/2) into the float, (Fig. 40/3) ensuring proper magnetic pole orientation (north pole toward device outlet)



Fig. 41: Insert inner parts

2. ➤ Insert the float with magnets and spring into the device body (inlet) (Fig. 41)



Fig. 42: Insert snap ring (inlet)

- 3.** → Insert snap ring into the device body (inlet) (Fig. 42)





Fig. 43: Secure snap ring in groove

- 4.** → Secure the snap ring in the groove, using the snap ring pliers (Fig. 43)so, that the float is properly held inside the device



Fig. 44: Check for smooth operation

5.  Check the float for ease of movement (Fig. 44) by applying light pressure with the test rod
 - ⇒ If the float is sluggish in movement, disassemble the device  Chapter 8.4 “Disassembly” on page 52 and clean the float and device body bore



If the float is still sluggish after having been cleaned several times, contact the manufacturer.

8.5.4 Switch contact replacement

Tools:

- Flat-bladed screwdriver

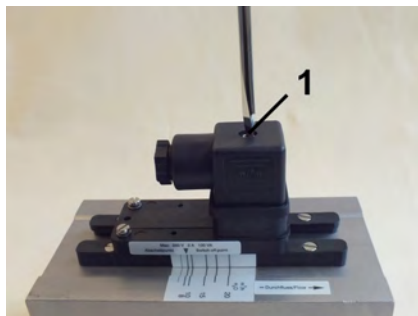



Fig. 45: Loosen female socket

1.  Loosen the fixing screw of the female socket (Fig. 45/1) with a flat-bladed screwdriver

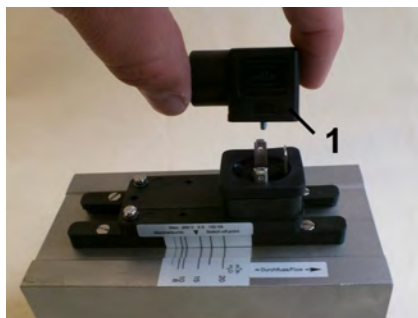



Fig. 46: Remove female socket

2.  Remove the female socket and gasket (Fig. 46/1) by pulling upwards

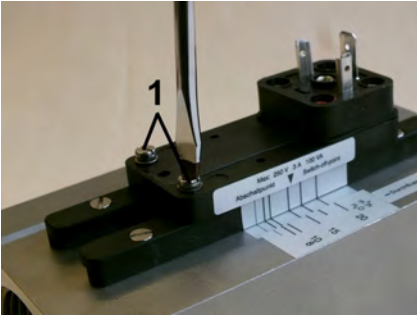

Fig. 47: Loosen set screws

3. ➤ Using a flat-bladed screwdriver (Fig. 47/1), loosen the set screws of the switch contact until it moves freely

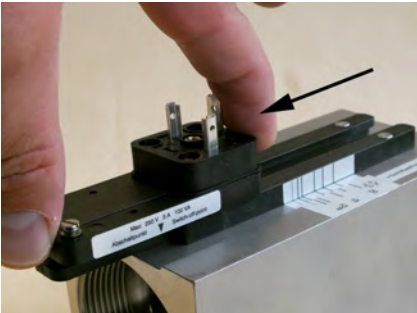

Fig. 48: Remove the switch contact from guide rails

4. ➤ Slide the switch contact from the guide rails (Fig. 48) in the direction of the arrow

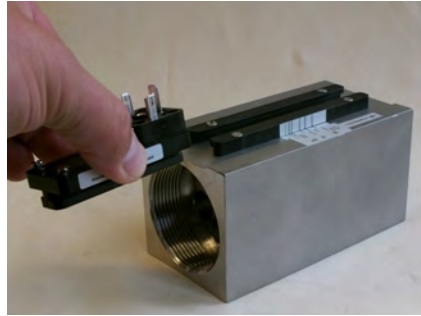

Fig. 49: Remove switch contact

5. ➤ Remove the switch contact from the device
6. ➤ Position the new switch contact
7. ➤ Slide the switch contact onto the guide rails
8. ➤ Connect a continuity meter. For Normally Open Contact (NOC), pin 1 and pin 2 are assigned; for Change Over Contact (COC), pin 1 and pin 3 are assigned
9. ➤ Slide the switch contact in the opposite direction of flow up to the stop. The switch contact must now be closed.
10. ➤ Slowly push the switch contact in the direction of flow until the contact opens. This switch point should be set as precisely as possible because it affects the accuracy of the switch point adjustment scale values (if needed, repeat steps 9 and 10).

- 11.** ▶ Retighten the set screws (Fig. 47/1) observing the proper tightening torque of the screws (*↪ Chapter 11.1 “Tightening torque” on page 69*)
- 12.** ▶ Affix the enclosed switch contact label to the side of the switch contact so that the reference arrow is aligned with the lowest scale mark. If a reference tick mark is on the data plate (recognizable as a thinner line), it is to be used as the alignment mark. The adhesive surface must be dry and free of oil and grease.
- 13.** ▶ Adjust the desired flow rate (cut-off point) on the switch point adjustment scale
- 14.** ▶ Attach the female socket and gasket and tighten the fixing screw.

Switch contact replacement and calibration to operator specifications must be done by the manufacturer.

8.6 Measures to be taken after maintenance work

Take the following steps after completion of maintenance work and before switching on the device:

- 1.** ▶ Check all previously loosened/ released screw connections for tightness.
↪ Chapter 11.1 “Tightening torque” on page 69
- 2.** ▶ Clean the work area and remove all residual materials, packaging, substances or spills.

9 Disassembly and disposal

After its period of useful life, the device must be disassembled and disposed of in an environmentally safe manner.

9.1 Safety



WARNING!

Risk of injury if disassembled incorrectly!

Media residue, sharp edged components, pointed ends and corners on and in the device or on tools may cause injuries.

- Ensure that the site is sufficiently cleared before commencing work
- Always wear protective equipment when handling dangerous media residue
- Handle open, or sharp-edged components carefully
- Ensure that the workplace is orderly and clean! Components and tools that are lying about or on top of each other are potential causes of accidents
- Disassemble components professionally
- Secure components so that they do not fall or overturn
- In case of doubt, contact the manufacturer

9.2 Disassembly

Before starting disassembly:







- Remove operating materials and supplementary supplies and dispose of properly.

Personnel:

- Qualified personnel

Protective equipment:

- Protective gloves
- Goggles

1.  Remove the device from the pipeline ( *Chapter 8.3 "Removal from the pipe system" on page 51*)
2.  Disassemble the device ( *Chapter 8.4 "Disassembly" on page 52*)
3.  Clean components properly and remove media residue
4.  Dispose in an environmentally safe manner

9.3 Return Materials

9.3.1 Return Materials Authorization

For products being returned, regardless of the reason, the currently valid provisions of the returns policy set by MEISTER will apply. Return shipments which do not comply with the returns policy may be refused by MEISTER at the expense of the consignor.

9.4 Disposal

If no return or disposal agreement has been made then recycle disassembled components:

- Scrap metals
- Recycle plastic elements
- Dispose of the remaining components according to their material properties

! NOTICE!

Danger to the environment due to incorrect disposal!

Potential risk to the environment may arise due to incorrect disposal.

- Have electrical scrap, electronic components, lubricants and other supplies disposed of by approved specialists
- In case of doubt, get information on environmentally safe disposal from the local authority or special disposal expert

10 Technical data

10.1 Device data plate

The data plate is on the mechanical part of the flow monitor/flow meter and contains the following information:



Fig. 50: Device data plate

10.2 Switch contact data plate

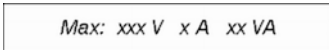

Fig. 51: Switch contact data plate

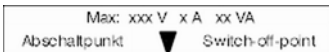
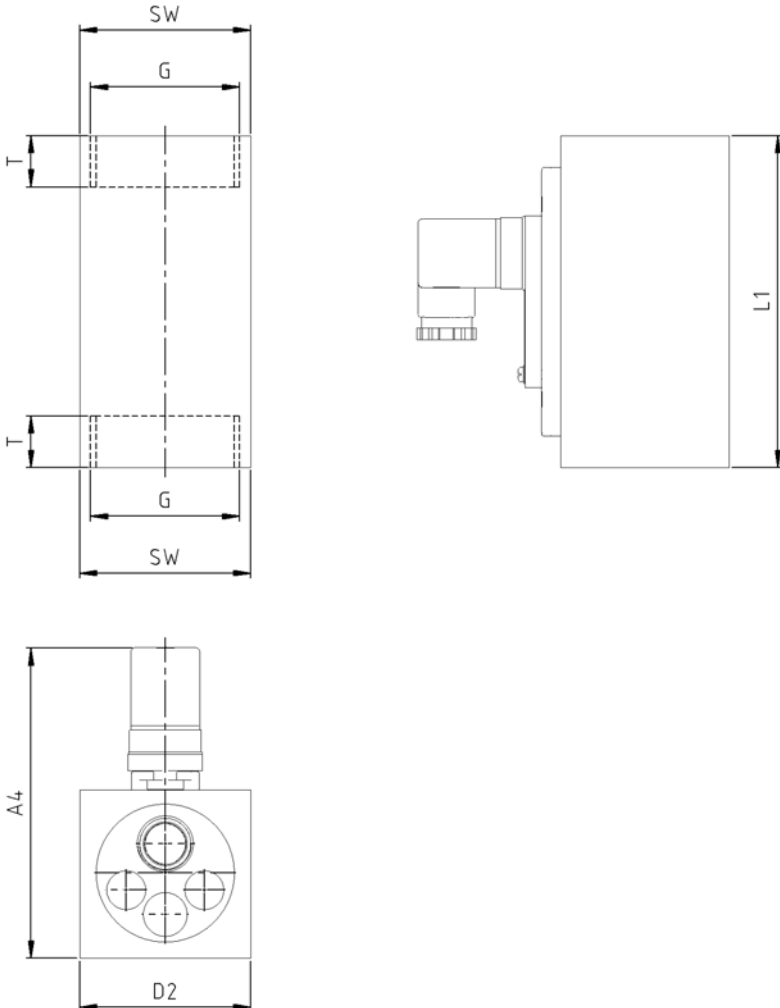

Fig. 52: Switch contact data plate with positioning arrow

The data plate is on the switch contact housing and may provide the following information:

- maximum voltage
- maximum current
- maximum power
- positioning arrow for cut-off point

10.3 Dimension sheet



10.4 General specifications

Type	Overall dimensions (mm)					
	G *	DN	SW	L1	L2	T
WBMC	2	50	70	136	-	25

Type	Overall dimensions (mm)							Weight (g) **
	G *	D1	D2	A1	A2	A3	A4	
WBMC	2	-	70	-	-	-	ca. 128	1340

* NPT thread on request

** Connection cable weight, 2m approx. 80g

10.5 Electrical specifications

Change-Over Contact (COC)

Data	Value	Unit
Voltage	250	V
Current, maximum	1,5	A
Power, maximum	50	VA
Minimum load	3	VA

Normally Open Contact (NOC)

Data	Value	Unit
Voltage	250	V
Current, maximum	3	A
Power, maximum	100	VA

Change-Over Contact (COC) M12x1 (-20 °C–85 °C)

Data	Value	Unit
Voltage	250	V
Current, maximum	1,5	A
Power, maximum	50	VA
Minimum load	3	VA

Normally Open Contact (NOC) M12x1 (-20 °C–85 °C)

Data	Value	Unit
Voltage	250	V
Current, maximum	3	A
Power, maximum	100	VA

Change-Over Contact (COC) PLC

Data	Value	Unit
Voltage	250	V
Current, maximum	1	A
Power, maximum	60	VA

10.6 Measuring ranges

10.6.1 Standard measuring ranges

Type	Switch point for H ₂ O bar at 20 °C*		
		[m ³ /h]	
Lowest switch point		8	
Highest switch point		20	

* The specified data are switch-off points; other switch ranges are available on request.

10.7 Operating data

Description	Value	Unit
Max. media temp.	100 (optional 160°C)	°C
Min. media temp. It must be ensured that the medium does not freeze	-20	°C
Max. operating pressure	180	bar Stainless steel (1.4571)
Pressure loss at 20 m ³ /h	0,2	bar
Measuring accuracy	± 10 % of full scale value	

Operating data for devices employed in explosion hazard zones differs from the above.

The operating data for devices employed in explosion hazard zones are specified in the Operating Instructions for "WBMC Module ATEX", Chapter 4.

11 Appendix

11.1 Tightening torque

Component/function	Description	Size	Torque	Qty
Guide rail screw	Countersunk screw with slot	M3x10	0,4 Nm	4
Switch contact	Cylinder head screw with slot	M3x8	0,4 Nm	2

11.2 Replacement parts list

The following replacement parts drawing provides an example of the construction of a WBMC type flow monitor. The actual configuration may vary depending on the model.

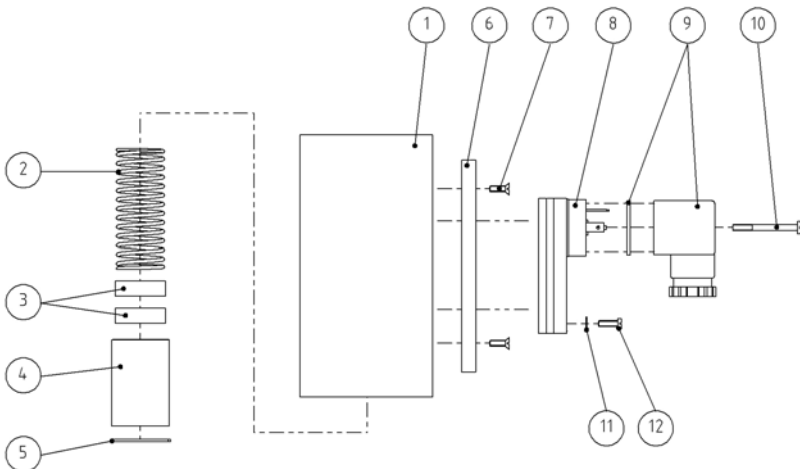

Item	Qty	Description
1	1	Device body
2	1	Spring
3	2	Magnet
4	1	Float
5	1	Snap ring
6	2	Guide rail
7	4	Fixing screws, (guide rail)
8	1	Switch contact with male connector
9	1	Female socket and gasket
10	1	Fixing screw (female socket)
11	2	Washer
12	2	Set screw (switch contact)

11.3 Tools

The following tools are required:

Tools

- Fixed spanner 70 mm
- Pipe wrench 2"
- Inner snap ring pliers (size J4/19-60mm)
- Flat-bladed screw driver, blade width 5,5 mm
- Torque screwdriver and assorted blades

Special tools

- Test rod WBMC
- Magnetic pole indicator

11.4 Sealant



Before using a sealant, ensure that it is compatible with the media used and that it can be employed under the given operating conditions.

- Ensure proper seal
- Use a suitable sealant. Liquid sealants will damage the flow monitor
- Always follow the sealant manufacturer's instructions

11.5 Lubricants



Before using a lubricant, always make sure that it is compatible with the operating medium.

For the proper mounting of O-rings, an O-ring installation tool may be purchased from the manufacturer.

The following lubricants are suitable to facilitate installing the O-rings:

Lubricant	O-ring material		
	NBR	EPDM	FKM
Glycerine*	suitable	suitable	suitable
Soapy water	suitable	suitable	suitable

* Glycerine must not be used if the device is used for sulfuric acid and/or nitric acid.

12 Index

- A**
 Assembly 56
- C**
 Cable 37
 Component groups 21
 Connector
 DIN 43650 36
 Contact 7
 Contact protection measures 40
 Copyright 3
 Correct use 10
 Customer service 7
- D**
 Degree of protection
 IP-Code 38
 Device data plate 64
 Device description 20
 Dimension sheet 65
 Disassembly
 Disposal 62
 Maintenance 52
 Disposal 63
- E**
 Electrical connection 35
 employment 10
 Environmental protection 17
 Cleaning fluids 17
 Lubricants 17
- F**
 Fault table 48
- G**
 General
 safety 8
- H**
 Hazard
 Electrical current 11
 Hazards
 mechanical 12
 Media 14
 Radiation 13
 Temperature 13
- I**
 Initial startup 34
 Installation
 pipe line 30
 preparatory work 26
- L**
 Limitation of liability 3
 Lubricant 71
- M**
 Maintenance 55
 Maintenance plan 51
 Measuring range 68
- O**
 Operating conditions 68
 Overview 20
 Owner 17
- P**
 Packaging 22
 Parts replacement 56
 Plug connection 38
 Plug connector
 M12x1 37
 Precautions
 general 11
 Preparation
 device 29

R

Read-off	45
Replacement parts	16, 69
Return Materials Authorization	63

S

Safety	
Disassembly	62
Safety equipment	15, 16
Safety instructions	
Transport	22
Sealant	70
Service	7
Special tools	70
Specifications	
Change-Over Contact	66
Normally Open Contact	66
Storage	23
Strainer	29
Switch contact	21
replacement	59
Switch contact data plate	64

Switch point adjustment scale	21
Switch point setting	43
Switch value	45
Symbols	
Packaging	23
Symbols used	
in the instructions	8

T

Technical data	
General specifications	66
Tightening torque	69
Tightening torque of screws	69
Tools	70
Transport inspection	22

U

Unimpeded flow section	27
----------------------------------	----

W

Warranty and guarantee provisions	7
---	---