

Operating instructions

RVO/U-L4 Module ATEX Flow Monitor



Flow monitor for use
in explosion-hazard zones

Series RVO/U-L4

Type RVO/U-L40001 thru RVO/U-
L40042

with switch contact
SG-15EX*****

Read this manual prior to performing any task!

Meister Strömungstechnik GmbH
Im Gewerbegebiet 2
63831 Wiesen
Germany
Telephone: +49 6096 9720 - 0
Fax: +49 6096 9720 - 30
E-mail: sales@meister-flow.com
Internet: www.meister-flow.com

RVO/U-L4 Modul ATEX, 2, en_US

These instructions were compiled by:
Meister Strömungstechnik GmbH
Subject to change without notice

© Meister Strömungstechnik GmbH 2019

These instructions facilitate the safe and efficient handling of a flow monitor (referred to as "device" in the following). The instructions are an integral part of the device and must be kept within easy reach for the personnel in the immediate vicinity of the device at all times. Personnel must carefully read and understand these instructions before commencing all work. The basic requirement for safe work is adherence to all safety and handling instructions stipulated in these instructions. The local accident-prevention regulations and general safety standards and regulations for the field of application of the device also apply. Illustrations in these instructions are provided to aid general understanding and might deviate from the actual model. No claims can be derived from any such differences.

Limitations of liability

All details and instructions in this manual have been compiled under consideration of the valid standards and regulations, the current state-of-technology and our many years of knowledge and experience. The manufacturer does not accept any liability arising from:

- non-observance of any details in these instructions
- improper use of the device, or use that is not in accordance with these instructions
- use of non-trained personnel

- unauthorized retrofitting or technical changes that have not been authorized by the manufacturer
- use of non-approved replacement parts

The duties and obligations agreed upon in the delivery contract apply in full, as well as the general terms and conditions, the terms of delivery by the manufacturer and the valid legal regulations applicable at the conclusion of the contract.

Copyright

These operating instructions are protected by copyright.

Except for internal purposes, transfer of these instructions to third-parties, copying them in any way – even in part – as well as dissemination and/or communication of their content is forbidden without prior written authorization from Meister Strömungstechnik ("manufacturer"). Violations are subject to claims for indemnification. The manufacturer reserves the right to assert additional claims.

Copyright is the property of the manufacturer.

© Meister Strömungstechnik GmbH

Im Gewerbegebiet 2

63831 Wiesen

Germany

Table of contents

1	Overview	6
	1.1 Short description.....	6
	1.2 Warranty and guarantee provisions.....	6
	1.3 Customer service.....	6
2	Safety	7
	2.1 Explanation of symbols.....	7
	2.2 Correct use in explosion-hazard zones.....	8
	2.3 Special precautions for use in explosion-hazard zones.....	10
	2.3.1 Precautions for use in explosion-hazard zones.....	11
	2.4 Personnel requirements.....	12
	2.5 Personal safety equipment.....	13
	2.6 Protective systems.....	13
3	Areas of employment	14
	3.1 Mechanical component (flow meter without limiting contacts and electrical components).....	14
	3.1.1 Exterior of the device.....	14
	3.1.2 Interior of the device.....	14
	3.1.3 General safety information for the mechanical component of the device.....	15
	3.1.4 Categorization of the mechanical component of the flow monitor..	16
	3.1.5 List of media.....	19
	3.1.6 Applicable documents.....	21
	3.2 Electrical component of the device (limiting contacts).....	24
	3.2.1 Categorization of the electrical components (limiting contacts).....	24
	3.2.2 Applicable documents.....	24
4	Operating data	33
	4.1 Operating data for the mechanical component of the device.....	33
	4.2 Switch contact operating data.....	33
	4.3 Labeling of the switch contacts.....	35
5	Transport, packaging and storage	36

6	Installation and initial startup	37
	6.1 Safety.....	37
	6.2 Tools.....	37
	6.3 Protection of the sight glass.....	37
	6.4 Electrical connection.....	37
	6.5 Grounding the device.....	37
	6.6 Contact protection measures.....	37
7	Operation	39
8	Troubleshooting	40
9	Maintenance	41
	9.1 Return Materials.....	41
	9.1.1 Return Materials Authorization.....	41
10	Disassembly and disposal	42
11	Technical data	43
	11.1 Dimension sheet.....	43
	11.2 General specifications.....	44
	11.3 Replacement parts.....	46
12	Annex	48
13	Index	49

1 Overview

1.1 Short description



Fig. 1: RVO/U-L4 flow monitor

- 1 Sight glass with measuring scale
- 2 Explosion-proof switch contact SG-15EX*****

The flow monitor RVO/U-L4 monitors the continuous flow of gaseous media. It is designed for installation into pipe systems.

A float inside the device is moved by the medium flowing through it. The current rate of flow can be read off on the measuring scale on the sight glass. The top edge of the float is the read off point.

Electrical monitoring is accomplished through the explosion-proof switching contacts SG-15EX*****. The electrical connection is via the cast-on power cable or various other connectors.

1.2 Warranty and guarantee provisions

Warranty and guarantee provisions are contained in the general terms and conditions of the manufacturer.

1.3 Customer service

For technical information, please contact our customer service department (for contact details, see Page 2).

Furthermore, our staff is always interested in receiving new information and experiences gained from application of the device, which might be useful in improving our products.

2 Safety

This Chapter provides an overview of important safety aspects required for optimum protection of personnel as well as for safe installation and safe operation of the device.

Non-observance of the handling and safety instructions listed in this manual may result in hazardous/dangerous situations and in damage to property.

2.1 Explanation of symbols

Safety instructions

Safety instructions in this manual are marked by symbols. The safety instructions are preceded by signal words that indicate the level of danger/hazard.

To prevent accidents or injuries to persons as well as damage to property, always observe the safety instructions and proceed carefully.



DANGER!

This combination of symbol and signal word indicates an immediate, dangerous situation that results in death or serious injury if it is not avoided.



WARNING!

This combination of symbol and signal word indicates a possibly dangerous situation that might result in death or serious injuries if it is not avoided.

**CAUTION!**

This combination of symbol and signal word indicates a possibly dangerous situation that might result in minor or slight injuries if it is not avoided.

**NOTICE!**

This combination of symbol and signal word indicates a possibly dangerous situation that might result in damage to property and to the environment if it is not avoided.

Tips and recommendations

This symbol emphasizes useful tips and recommendations as well as information for efficient and failure-free operation.

Signs used in these instructions

The following symbols and highlighting are used in these instructions to identify handling instructions, the description of results, lists/enumerations, references and other elements:

- ➔ Designates step-by-step handling instructions.
- ⇒ Designates a state or an automatic sequence as a result of a specific operating step.
- Designates randomly ordered enumerations and list entries

🔗 *“Signs used in these instructions” on page 8*, designates references to chapters in these instructions.

2.2 Correct use in explosion-hazard zones

The device has been designed and constructed exclusively for the correct use in accordance with these instructions.

The flow monitor serves exclusively to monitor the continuous flow of gaseous media.

The areas of application are specified in Chapter 3 of these instructions.

The admissible operating conditions are specified in Chapter 4 of these instructions.

Correct use of the device includes the observance of all specifications in these Operating Instructions, as well as those for "RVO/U-L4 Module BASICS".

Any additional or different application, above and beyond the correct use in accordance with these instructions, is deemed as incorrect use.

 **WARNING!**

Danger due to incorrect use!

- Use the flow monitor only within the stipulated performance limits
- Do not subject the flow monitor to severe temperature fluctuations
- Do not use the flow monitor with quick-acting valves
- Do not use the flow monitor with solenoid valves
- Do not subject the flow monitor to vibrations
- Do not subject the flow monitor to pressure surges
- Do not use the flow monitor with media containing solids or abrasives
- Only use the flow monitor with media previously approved by the manufacturer
- Do not use the flow monitor as the sole monitoring device to prevent dangerous situations
- Do not install the flow monitor as a load bearing part within a pipeline system
- The flow monitor with sight glass must be installed in such a way as to preclude damage to the sight glass by outside force. If necessary, install an appropriate impact protection device

- The flow monitor may be installed in explosion-hazard zones only if:
 - the labeling on the flow monitor,
 - the labeling on the switch unit installed on the flow monitor,
 - and the information contained in the accompanying documentation (Operating instructions "RVO/U-L4 Module BASICS" and "RVO/U-L4 Module ATEX"), authorize such installation and operation
- Planning and design of equipment, protective systems and components is the responsibility of the facility operator
- The potential impact, in case of an explosion, must be taken into account by the facility operator
- The facility operator is responsible for the substitution, or the reduction of the quantity of substances, which may cause an explosive atmosphere.

All claims for damages due to incorrect use are excluded.

Incorrect use of the flow monitor may result in dangerous conditions.

2.3 Special precautions for use in explosion-hazard zones

The following chapter lists residual risks that might arise from the device.

To reduce health risks and prevent dangerous conditions, observe the safety instructions listed here, the safety instructions listed in other chapters of these operating instructions, as well as all safety instructions listed in the Operating Instructions for "RVO/U-L4 Module BASICS".



These Operating Instructions cannot cover all conceivable dangers because many dangers arise, not from the device itself, but from the respective media flowing through it. Always observe the appropriate safety data sheets when using hazardous media!

2.3.1 Precautions for use in explosion-hazard zones



DANGER!

Danger to life from explosions

- Potentially explosive dust-air mixtures and hybrid mixtures are not allowed inside the flow meter/flow monitor and must be excluded by the operator!
- Dust accumulations are not permitted, neither inside nor on the outside surface of the flow meter/flow monitor and must be excluded by the operator! When cleaning, do not use dry cloths!
- To avoid electrostatic charges capable of resulting in dangerous conditions, the following requirements must be met:
 - All conductive parts, capable of electrostatic charging, must be connected and grounded
 - Dangerous electrostatic charging of non-conductive parts and materials, including solids, fluids and dust, must be avoided.
 - Ignitable discharges must be excluded.

- Chemical reactions, pyrolysis or biological processes inside the flow meter/flow monitor are not permitted and must be excluded by the operator.
- The entry of foreign materials which may produce sparks is not permitted and must be excluded by the operator.
- Friction, which may cause local heat build-up and sparking, is not allowed and must be excluded by the operator.
- Impact processes, involving materials such as rust or light alloys (e.g. aluminum or magnesium) are not allowed and must be excluded by the operator.
- High voltage and currents which may cause sparking are not allowed and must be excluded by the operator.
- Electromagnetic waves in a frequency range between 10^4 to 3×10^{12} Hz, as may be found in the vicinity of radio broadcasting stations or high-frequency generators, are not allowed and must be excluded by the operator.

- Electromagnetic waves in a frequency range between 3×10^{11} to 3×10^{15} Hz, which can occur as radiation from protective systems or components (e.g. lamps, arc lamps, lasers), are not allowed and must be excluded by the operator.
- Devices which can focus radiation, and which can provide an ignition source for particles and surfaces, are not allowed and must be excluded by the operator.
- Ionizing radiation which exceeds the minimum ignition temperature of the surrounding explosive atmosphere, is not allowed and must be excluded by the operator.
- Ultrasound sources, which can ignite the sonicated material, are not allowed and must be excluded by the operator.
- Adiabatic compression and shock waves are not allowed and must be excluded by the operator.
- Exothermic reactions, including auto-ignition of dust, is not allowed and must be excluded by the operator.

2.4 Personnel requirements



WARNING!

Risk of injury due to insufficiently trained and qualified personnel!

If unqualified personnel work on the device or are located within its hazard zone, dangers arise which may result in serious injuries and considerable damage to property.

- All work must be performed by qualified personnel only.
- Keep unqualified personnel away from hazard zones.

The personnel requirements, as formulated in the Operating Instructions for "RVO/U-L4 Module BASICS" Chapter 2.4, are valid. For employment within explosion-hazard zones, only trained and qualified personnel may be used. Responsibility for the choice of personnel and their qualification rests with the facility operator. The requirements for standards DIN EN 60079-14 and DIN EN 60079-17 must be taken into consideration.

Refer also to the Operating Instructions "RVO/U-L4 Module BASICS", Chapter 2.9 "Responsibility of the owner".

Authorized personnel is to be restricted to those persons who can be expected to carry out their work reliably. Persons whose ability to respond is influenced, e.g. by drugs, alcohol or medication, are not authorized.

Observe the age and occupational regulations at the site when choosing personnel.

2.5 Personal safety equipment

Personal safety equipment is used to protect personnel from hazards/dangers that might impair their safety or health during work.

When performing the various tasks at, and with the device, personnel must wear personal safety equipment. Special reference to this equipment is made in the Operating Instructions for "RVO/U-L4 Module BASICS". The facility operator must ensure that the protective clothing used in explosion-hazard zone is suitable and approved.

2.6 Protective systems

The design of the safety features is described in the Operating Instructions "RVO/U-L4 Module BASICS". The operator must ensure that all applicable regulations which apply to operation in explosion-hazard zone are met.

3 Areas of employment

3.1 Mechanical component (flow meter without limiting contacts and electrical components)

3.1.1 Exterior of the device

- Devices of the RVO/U-L4 type may be employed in areas in which an explosive atmosphere, composed of a gas/air- or dust/air-mixture, may occasionally occur. The exterior of the device may therefore be suitably located in explosion hazard zone 1, zone 2, zone 21, or zone 22.
- Dust accumulations are not permitted; neither internally, nor on the outside surface of the flow meter/flow monitor and must be excluded by the operator.

3.1.2 Interior of the device

- Internal to the device, only those flow media may be used, to which the following applies:
- the medium is listed on the media list (Chapter 3.1.5), and
- the medium is not aggressive to the wetted parts of the device, and
- the device is approved by the manufacturer for use with the medium
- It is permissible to occasionally have an explosive gas/air mixture inside the device (explosion hazard zone 1). At no time may gasses of explosion hazard group IIC (e.g. hydrogen or acetylene) be present inside the device.
- Explosive dust-air mixtures and hybrid mixtures are not permitted inside the flow meter/flow monitor and must be excluded by the operator.
- Chemical reactions, pyrolysis or biological processes inside the flow meter/flow monitor are not permitted and must be excluded by the operator
- The entry of foreign materials which may produce sparks is not permitted and must be excluded by the operator.

3.1.3 General safety information for the mechanical component of the device

- Dust accumulations are not permitted; neither internally, nor on the outside surface of the flow meter/flow monitor and must be excluded by the operator. When cleaning, do not use dry cloths!
- In case of hazard through static electricity, the following requirements must be met:
 - All conductive parts capable of charging themselves electrostatically must be connected and grounded
 - Dangerous electrostatic charging of non-conductive parts and materials, including solids, fluids and dust, must be avoided
 - Ignitable discharges must be excluded
- Friction, which may cause local heat build-up and sparking, is not allowed and must be excluded by the operator
- Impact processes involving materials such as rust or light alloys (e.g. aluminum or magnesium) are not allowed and must be excluded by the operator
- High voltage and currents that may cause sparking are not allowed and must be excluded by the operator
- Electromagnetic waves in a frequency range between 10^4 to 3×10^{12} Hz, as may be found in the vicinity of radio broadcasting stations or high-frequency generators, are not allowed and must be excluded by the operator
- Electromagnetic waves in a frequency range between 3×10^{11} to 3×10^{15} Hz, which can occur as radiation from protective systems or components (e.g. lamps, arc lamps, lasers), are not allowed and must be excluded by the operator
- Devices which can focus radiation, and which can provide an ignition source for particles and surfaces, are not permitted and must be excluded by the operator
- Ionizing radiation which exceeds the minimum ignition temperature of the surrounding explosive atmosphere, is not allowed and must be excluded by the operator
- Ultrasound sources, which can ignite the sonicated material, are not allowed and must be excluded by the operator
- Adiabatic compression and shock waves are not allowed and must be excluded by the operator

- Exothermic reactions, including auto-ignition of dust, is not allowed and must be excluded by the operator
- The flow monitor must be installed in such a way as to preclude damage by outside force. This is especially so for devices with sight glass. It must be ensured that the sight glass cannot be damaged. If necessary, install an appropriate impact protection shield.

3.1.4 Categorization of the mechanical component of the flow monitor

- Equipment group
internal: II
external: II
- Equipment category
internal: 2
external: 2
- Atmosphere
internal: Gas (G)
external: Gas (G), Dust (D)
- Type of protection: h (Constructional Safety "c")
- Gas group
internal: IIB
external: IIC, IIIC
- Temperature classification
internal: T5, T6
external: T100 °C, T80 °C
Operating temperatures for a device without limit switch contacts
The maximum media temperature for a device without limit switch contacts must be less than:
 - the ignition temperature of the medium and
 - the ignition temperature of the atmosphere surrounding the device and
 - less than or equal to 100 °C

It is the responsibility of the operator to ensure that these requirements are met concurrently.

The **minimum media temperature for a device without limit switch contacts** must be higher than or equal to - 20 °C.

It must be ensured that the medium does not freeze.

The **maximum ambient temperature for a device without limit switch contacts** must be less than:

- the ignition temperature of the medium and
- the ignition temperature of the atmosphere surrounding the device and
- less than or equal to 100 °C

It is the responsibility of the operator to ensure that these requirements are met concurrently.

The **minimum ambient temperature for a device without limit switch contacts** must be higher than or equal to - 20 °C.

Operating temperatures for a device with the following limit switch contacts:

Explosion-proof switch contacts, series SG-15EX***** with design examination:

EPS 13 ATEX 1 596 U

The **maximum media temperature for a device with these limit switch contacts** must be less than:

- the ignition temperature of the medium and

- the ignition temperature of the atmosphere surrounding the device and
- less than 45 °C

It is the responsibility of the operator to ensure that these requirements are met concurrently.

The **minimum media temperature for a device with these limit switch contacts** must be higher than - 5 °C .



It must be ensured that the medium does not freeze.

The **maximum ambient temperature for a device with these limit switch contacts** must be less than:

- the ignition temperature of the medium and
- the ignition temperature of the atmosphere surrounding the device and
- less than 45 °C

It is the responsibility of the operator to ensure that these requirements are met concurrently.

The **minimum ambient temperature for a device with these limit switch contacts** must be higher than - 5 °C.

- EPL (Equipment Protection Level): Gb (Gas), Db (Dust)
- Labeling of the mechanical component of the flow meter/monitor:
 - internal:  II 2G Ex h IIB T5, T6 Gb
 - external:  II 2G Ex h IIC T5, T6 Gb

Areas of employment



Mechanical component (flow meter without limiting contacts and electrical components) > Categorization of the mechanical component of the flow monitor

external:  II 2D Ex h IIC T100
°C, T80 °C Db

3.1.5 List of media

Media used		Ignition temp.	Explosion limit [%]	
			Lower	Upper
Argon		Inert gas		
Cargon	Gaseous mixture Argon+ CO ₂			
CO ₂		Inert gas		
CO ₂ liquid				
Diesel		255 (ASTME659-78)	0,6	6,5
Biodiesel SME	Soya seed oil methyl ester	285 (ASTME659-78)		
Biodiesel RME	Rape seed oil methyl ester	283 (ASTME659-78)		
EDC	(1,2-Dichlorethane)	440	6,2	16
Natural gas		575 - 640	4	17
Ethanol		400	3,1	
City gas		560		
Gaseous mixture 90 % Argon + 10 % CO ₂				
Gaseous mixture 96 % Argon + 4 % O ₂				
Helium		none	none	none
Air				
Methane		595	4,4	16,5

Media used		Ignition temp.	Explosion limit [%]	
			Lower	Upper
Methanol		455	6,1	44
N ₂		none	none	none
N ₂ O		none	none	none
NaOH	Natrium-hydroxide-NaOH ("caustic soda")	none	none	none
NaOH 50%		none	none	none
Caustic soda NaOH 25%		none	none	none
NH ₃	Anhydrous ammonia	630	15	28
n-Heptan (highly purified)		215	1	6,7
O ₂		none	none	none
Oil				
organic Salt solution density 1,35 kg/l 20 °C				
Peroxide		none	none	none
RAF2	Raffinate 2	385	1,6	10
Spirits of Ammonia (25%)		630	15	28
SO ₂	Sulphur dioxide	none	none	none

Media used		Ignition temp.	Explosion limit [%]	
			Lower	Upper
Solvana 2000 (Universal cleaning agent)		236	0,4	7
Petroleum ether		>200	0,6	7
Water		none	none	none
Water / Nitrite-solution				
Hydrogenperoxyde 50% (ultra pure)		none	none	none
Hydrogenperoxyde 50 weight.-%, dissolved in Water		none	none	none
Propane		470	2,2	9,5
n-Butane		365	1,4	8,5

3.1.6 Applicable documents

Meister Strömungstechnik GmbH
Im Gewerbegebiet 2
63831 Wiesen
Germany

EU-Declaration of Conformity

in accordance with EU-Directive 2014/34/EU
on equipment and protective systems intended for use
in potentially explosive atmospheres

We declare under sole responsibility, that the products listed below are in compliance with the requirements of EU-Directive 2014/34/EU and that these products are not stand alone devices, but are intended for installation as a part of a machine or system, whereby operation is prohibited until such time as it is ensured that the machine or system, in its entirety, is in compliance with the EU-Directives.

Float-type Flowmeter, Series RVO/U-L4

The flowmeter is used for measuring and monitoring the continuous volume flow of gases, is suitable for use with explosion-proof limit switches labeled SG-15EX *****
(Type examination EPS 13 ATEX 1596 U).

For these contacts, there is a separate Declaration of Conformity.

The float-type flowmeter, series RVO/U-L4 15x50, complies with the requirements of EU-Directive 2014/34/EU and is categorized as follows:

Interior of the flowmeter (Medium):

Equipment-group II, category 2 G, for gases of gas group IIB, temperature classification T5, T6

Marking: Interior  II 2G Ex h IIB T5, T6 Gb

Exterior of the Flowmeter:

Equipment-group II, category 2 G or 2 D, for gases of gas group IIC or combustible dust IIIC, temperature classification T5, T6 or T100°C, T80°C

Marking: Exterior  II 2G Ex h IIC T5, T6 Gb

 II 2D Ex h IIIC T100°C, T80°C Db

During the conformity appraisal procedures, it was found that no effectual ignition source is existent, if the device is employed and operated as intended and in compliance with all requirements of the operating instructions for RVO/U-L4 15x50 module BASICS and RVO/U-L4 15x50 module ATEX. Meister Strömungstechnik GmbH therefore affixes the Ex-marking under its own responsibility.

Conformity of the described product with Directive 2014/34/EU is proven through full compliance with the following standards:

Harmonized European standards:

DIN EN ISO 80079-36:2016

Explosive atmospheres - Part 36: Non-electrical equipment for explosive atmospheres - Basic method and requirements

DIN EN ISO 80079-37:2016

Explosive atmospheres - Part 37: Non-electrical equipment for explosive atmospheres - Non-electrical type of protection constructional safety "c", control of ignition sources "b", liquid immersion "k"

EN 1127-1:2019

Explosive atmospheres - Explosion prevention and protection - Part 1: Basics concepts and methodology

Copies of the technical documentation for the conformity appraisal procedure are deposited at:

Bureau Veritas Consumer Products Services Germany GmbH

Businesspark A96, 86842 Türkheim, Germany

Identification number of notified body: 2004

Accession number: 11TH0271

Place and date/

Name and signature of authorized person

Wiesen, August 10, 2020



Simon Mill
Managing Director

MASTERPIECES
MADE IN GERMANY

3.2 Electrical component of the device (limiting contacts)

The electrical limit switch contacts, series SG-15EX***** were subjected to design examination: EPS 13 ATEX 1 596 U

The component type and acceptable variations thereto is specified in the supplement to this certificate.

The electrical limiting contacts may only be employed in combination with RVO/U-L4 type devices in areas in which an explosive atmosphere, composed of a gas/air- or dust/air-mixture, may occasionally occur. The limiting contacts of the device may therefore be suitably located in explosion hazard zone 1, zone 2, zone 21 or zone 22. Dust accumulations are not permitted on the limiting contacts and must be excluded by the operator.

3.2.1 Categorization of the electrical components (limiting contacts)

- Device group: II
- Device category: 2
- Atmosphere: Gas (G), Dust (D)
- Gas group: IIC (Gas), IIIC (Dust)
- Ignition protection category: ib

The markings on the components must include the following:

 II 2G Ex ib IIC

 II 2D Ex ib IIIC

3.2.2 Applicable documents

The electrical limit switch contacts were subjected to a design examination

EPS 13 ATEX 1 596 U

The following documents must be observed:

Manufacturer's declaration for the employment of explosion-proof switch units within a safety concept

- Design examination certificate with attachment
- Conformity declaration (Meister Strömungstechnik GmbH)
- IECEX CoC+ ExTr
IECEX EPS 13.0026U



Meister Strömungstechnik GmbH
Im Gewerbegebiet 2
63831 Wiesen
Germany

Manufacturer's declaration

to the application of switch contacts,
Series SG-15EX***** with
EC-Type Examination Certificate
EPS 13 ATEX 1 596 U

The switch contact may only be used in conjunction with flow meters (hereinafter referred as „device units“), which have previously been approved by us.
The safety concept and its implementation by the operator of the plant, in which the device unit is used, must have mandatory, multiple levels of redundancy.
The device unit is not certified for employment as exclusive safety component in the event of a breakdown, disruption, or malfunction, which may cause damage or injury to persons, animals or property.
Therefore, the operator is solely liable; the liability of the manufacturer is, to the extent legally permitted, excluded.

Place and date

Wiesen, July 8, 2014

Legally binding signature of the authorized person



Rosemarie Mill
Managing Director



**BUREAU
VERITAS**



(1) **EC-Type Examination Certificate**

(2) Equipment and Protective Systems Intended for Use in Potentially Explosive Atmospheres –
Directive 94/9/EC

(3) EC-Type Examination Certificate Number

EPS 13 ATEX 1 596 U

Revision: 0

(4) Component: switching contact SG-15EX*****

(5) Manufacturer: Meister Strömungstechnik GmbH

(6) Address: Im Gewerbegebiet 2, 63831 Wiesen, Germany

(7) This component and any acceptable variation thereto are specified in the schedule to this certificate and the documents therein referred to.

(8) Bureau Veritas Consumer Products Services Germany GmbH, Notified Body No. 2004 in accordance with Article 9 of the Council Directive 94/9/EC of March 23rd 1994, certifies that this component has been found to comply with the Essential Health and Safety Requirements relating to the design and construction of equipment and protective systems intended for use in potentially explosive atmospheres, given in Annex II of the Directive. The examination and test results are recorded in the confidential report 13TH0246.

(9) Compliance with the Essential Health and Safety Requirements has been assured by compliance with:

EN 60079-0:2012

EN 60079-11:2012

(10) The sign "U" placed behind the certificate number indicates that this certificate should not be confounded with certificates issued for equipment or protective systems. This component certificate only serves as a basis for the issuing of certificates for equipment or protective systems.

(11) This EC-Type Examination Certificate relates only to the design and the construction of the specified component in accordance with Directive 94/9/EC. Further requirements of this Directive apply to the manufacture and supply of this component.

(12) The marking of the component shall include the following:

II 2C Ex ib IIC

II 2D Ex ib IIIC

Certification department of explosion protection

Türkheim, March 18, 2014

D. Zitzmann





**BUREAU
VERITAS**

(13)

Annexe

(14) **EC-Type Examination Certificate EPS 13 ATEX 1 596 U**

(15) Description of component:

The sealed switching contact is used on mechanical flow meters for electrical monitoring of flow limits and for connection to certified intrinsically safe circuits.

The operating temperature of $-5^{\circ}\text{C} < T_{\text{service}} < +45^{\circ}\text{C}$ must not fall below or exceeded.

Electrical data:

Li = 0 Ci = 0

Gas		
Ui	Ii	Pi
< 12,1 V	1,0 A	3,0 W
< 20 V	0,309 A	1,55 W
< 25 V	0,158 A	0,99 W
< 30 V	0,101 A	0,76 W

Dust		
Ui	Ii	Pi
< 12,1 V	0,250 A	0,75 W
< 20 V	0,250 A	0,75 W
< 25 V	0,250 A	0,75 W
< 30 V	0,250 A	0,75 W

(16) Test report: 13TH0246

(17) Special conditions for safe use:

The installation of the switching contact is defined in the type examination certificate for the respective electrical equipment

(18) Essential health and safety requirements:

Met by standards.

Certification department of explosion protection

Türkheim, March 18, 2014

D. Zitzmann



Page 2 / 2



IECEX Certificate of Conformity

INTERNATIONAL ELECTROTECHNICAL COMMISSION IEC Certification Scheme for Explosive Atmospheres

for rules and details of the IECEx Scheme visit www.iecex.com

Certificate No.: IECEx EPS 13.0026U Issue No: 0 Certificate history:
Status: Current Page 1 of 3 Issue No. 0 (2014-06-16)

Date of Issue: 2014-06-16

Applicant: Meister Strömungstechnik GmbH
Im Gewerbegebiet 2
63831 Wiesen
Germany

Electrical Apparatus: Schaltkontakt / switching contact SG-15EX*****
Optional accessory:

Type of Protection: i

Marking: Ex ib IIC
Ex ib IIIC

Approved for issue on behalf of the IECEx
Certification Body:

D. Zitzmann

Position:

Head of Certification

Signature:
(for printed version)

Date:



1. This certificate and schedule may only be reproduced in full.
2. This certificate is not transferable and remains the property of the issuing body.
3. The Status and authenticity of this certificate may be verified by visiting the [Official IECEx Website](http://www.iecex.com).

Certificate issued by:

Bureau Veritas Consumer Products Services Germany GmbH
Businesspark A96
86842 Türkheim
Germany





IECEX Certificate of Conformity

Certificate No: IECEx EPS 13.0026U Issue No: 0
Date of Issue: 2014-06-16 Page 2 of 3
Manufacturer: Meister Strömungstechnik GmbH
Im Gewerbegebiet 2
63831 Wiesen
Germany

Additional Manufacturing
location(s):

This certificate is issued as verification that a sample(s), representative of production, was assessed and tested and found to comply with the IEC Standard list below and that the manufacturer's quality system, relating to the Ex products covered by this certificate, was assessed and found to comply with the IECEx Quality system requirements. This certificate is granted subject to the conditions as set out in IECEx Scheme Rules, IECEx 02 and Operational Documents as amended.

STANDARDS:

The electrical apparatus and any acceptable variations to it specified in the schedule of this certificate and the identified documents, was found to comply with the following standards:

IEC 60079-0 : 2011 Explosive atmospheres - Part 0: General requirements
Edition:6.0
IEC 60079-11 : 2011 Explosive atmospheres - Part 11: Equipment protection by intrinsic safety "I"
Edition:6.0

This Certificate does not indicate compliance with electrical safety and performance requirements other than those expressly included in the Standards listed above.

TEST & ASSESSMENT REPORTS:

A sample(s) of the equipment listed has successfully met the examination and test requirements as recorded in

Test Report:

[DE/EPS/ExTR13.0027/00](#)

Quality Assessment Report:

[DE/EPS/QAR14.0007/00](#)



IECEX Certificate of Conformity

Certificate No: IECEX EPS 13.0026U

Issue No: 0

Date of Issue: 2014-06-16

Page 3 of 3

Schedule

EQUIPMENT:

Equipment and systems covered by this certificate are as follows:

Switching contact (component) used for control of flow valves mounted on mechanical flow meters for the connection to already certified intrinsic safe circuits.

The rated service temperature has to be in the limits of $-5^{\circ}\text{C} < T < +45^{\circ}\text{C}$.

For Intrinsic safe values see annex.

CONDITIONS OF CERTIFICATION: NO

Annex:

[Meis_annex to IECEX CoC_13TH0246_0_dr.pdf](#)

Annexe to: IECEx EPS 13.0026U issue No.:0
Applicant: Meister Strömungstechnik GmbH, Germany
Apparatus: Switching contact SG-15EX*****



Intrinsic safe values:

Li = 0 Ci = 0

Gas		
Ui	Ii	Pi
< 12,1 V	1,0 A	3,0 W
< 20 V	0,309 A	1,55 W
< 25 V	0,158 A	0,99 W
< 30 V	0,101 A	0,76 W

Dust		
Ui	Ii	Pi
< 12,1 V	0,250 A	0,75 W
< 20 V	0,250 A	0,75 W
< 25 V	0,250 A	0,75 W
< 30 V	0,250 A	0,75 W

Conditions for use:

- The rated service temperature has to be in the limits of $-5^{\circ}\text{C} < T < +45^{\circ}\text{C}$.
- Intended for the connection to already certified intrinsic safe circuits.

Meister Strömungstechnik GmbH
Im Gewerbegebiet 2
63831 Wiesen
Germany

Declaration of Conformity

In accordance with EU-Directive 2014/34/EU on equipment and protective systems intended for use in potentially explosive atmospheres (ATEX)

We declare under sole responsibility that the switch contacts listed below are in compliance with the requirements of EU-Directive 2014/34/EU. The switch units are not stand-alone components and may only be used in conjunction with flow meters which have previously been approved by us (hereafter referred to as „device unit“). The device unit is intended for installation as part of a machine or system, whereby operation is prohibited until such time as it is ensured that the machine or system, in its entirety, is in compliance with the relevant EU-Directives.

Component: Switch contact SG-15EX*****
Manufacturer: Meister Strömungstechnik GmbH
Address: Im Gewerbegebiet 2, 63831 Wiesen

The essential safety and health requirements are met by compliance with:

EN 60079-0:2014-06 EN 60079-11:2012-06

EC Type Examination Certificate: EPS 13 ATEX 1 596 U
Prepared by Bureau Veritas Consumer Products Services Germany GmbH

Place and date _____

Name and signature of authorized person _____

Wiesen, June 29, 2016



Rosemarie Mill
Managing Director

4 Operating data

Operating data for employment in explosion-hazard zones.

4.1 Operating data for the mechanical component of the device

The maximum operating pressure is specified in Chapter 10.7 of the Operating Instructions for "RVO/U-L4 Module BASICS".

The maximum media and ambient temperatures for the mechanical component depend on various factors. It is the responsibility of the operator to specify the maximum temperatures within the framework set by the guidelines in *Chapter 3.1.4 "Categorization of the mechanical component of the flow monitor"* on page 16 and ensure compliance thereto.

4.2 Switch contact operating data

Operating data for the explosion-proof switch units, series SG-15EX***** with design examination.

Certificate number: EPS 13 ATEX 1 596 U

This component and any acceptable variation thereto are specified in the schedule to this certificate and the documents therein referred to.

The sign "U" placed behind the certificate number indicates that this certificate should not be confounded with certificates issued for equipment or protective systems. This component certificate only serves as a basis for the issuing of certificates for equipment or protective systems.

Installation of the switch contact is set in the type certificate for the respective electrical equipment

The operating temperature limits of $-5\text{ °C} < T_{\text{Service}} < +45\text{ °C}$ must not be exceeded.

The following intrinsically safe limit values must not be exceeded, not even for brief periods:

Table 1: Electrical data - Gas

Ui	Ii	Pi
< 12,1 V	1,0 A	3,0 W
< 20 V	0,309 A	1,55 W
< 25 V	0,158 A	0,99 W
< 30 V	0,101 A	0,76 W
Li = 0		
Ci = 0		

Table 2: Electrical data - Dust

U_i	I_i	P_i
< 12,1 V	0,250 A	0,75 W
< 20 V	0,250 A	0,75 W
< 25 V	0,250 A	0,75 W
< 30 V	0,250 A	0,75 W
Li = 0		
Ci = 0		

4.3 Labeling of the switch contacts

The labeling of the components must contain the following information:

 II 2G Ex ib IIC

 II 2D Ex ib IIIC

Examples of the switch contact labels:

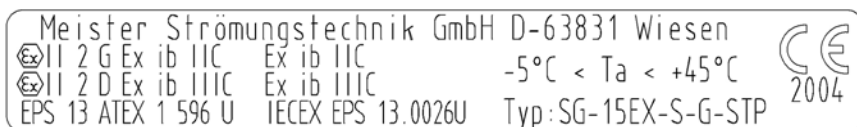

Fig. 2: Switch contact with connector EN 175301-803 (Form C)

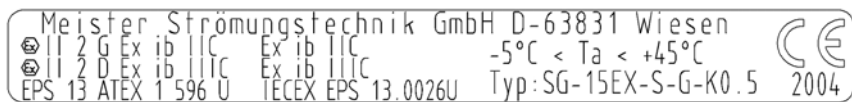

Fig. 3: Switch contact with cable

5 Transport, packaging and storage

Transport, packaging and storage in non-explosion-hazard zones are described in Chapter 4, "RVO/U-L4 Module BASICS".

In explosion-hazard zones, in addition to the requirements described in the above reference, all valid provisions for safety, accident prevention and environmental protection must be complied with.

Packaging procedures (wrapping/unwrapping) may only be conducted outside the explosion-hazard zone.



DANGER!

Danger to life if packaging procedures are conducted in explosion-hazard zones.

- Packaging procedures may only be conducted outside the explosion-hazard zone.

6 Installation and initial startup

Installation and initial startup in non-explosion-hazard zones are described in Chapter 5, "RVO/U-L4 Module BASICS". In addition, for installation and initial startup in explosion-hazard zones, the following sections must be observed:

6.1 Safety

All relevant safety-, accident prevention- and environmental protection regulations must be followed for employment in an explosion hazard zone.

6.2 Tools

Tools, which may cause sparks, are not to be employed. These tools may only be used when there is no potentially explosive atmosphere present.

The use of steel tools, of any kind, is prohibited in hazard zone 1, if there is risk of explosion due to substances in explosion hazard group IIC (in accordance with IEC/TR3 60079-20), (for example, acetylene, hydrogen).

6.3 Protection of the sight glass

The flow monitor with sight glass must be installed in such a way as to preclude damage to the sight glass by outside force.

The facility operator is responsible for the installation of an appropriate impact protection shield.

6.4 Electrical connection

Electrical connection is accomplished through the connection cable leading from the switch housing. All safety advisories contained in the Operating Instructions for "RVO/U-L4 Module BASICS", Chapter 5, must be observed. Additionally, for operation in explosion-hazard zones, all valid provisions for safety, accident prevention and environmental protection must be complied with.

6.5 Grounding the device

When installing the device in a pipe system, ensure that the device is grounded to the pipe system to avoid a dangerous electrical potential difference.

6.6 Contact protection measures

Recommendations for contact protection measures, when the device is employed in a non-explosion-hazard zone, are described in chapter 5.9 "Contact protection measures" of the Operating Instructions for "RVO/U-L4 Module BASICS". When the device is employed in an explosion-hazard zone, only those contact protection measures may be taken, which are

consistent with all valid safety and accident prevention measures for explosion-hazard zones and the specifications contained in these Operating Instructions.

7 Operation

Operation is described in Chapter 6, "RVO/U-L4 Module BASICS". All safety- and hazard warnings contained in Chapter 6, "RVO/U-L4 Module BASICS", must be followed. For operation in explosion-hazard zones, all valid provisions for safety, accident prevention and environmental protection must be complied with.

8 Troubleshooting

The procedures in case of malfunction are described in Chapter 7, "RVO/U-L4 Module BASICS". All safety- and hazard warnings, contained in Chapter 7, "RVO/U-L4 Module BASICS", must be followed. Additionally, for operation in explosion-hazard zones, all valid provisions for safety, accident prevention and environmental protection must be complied with.

9 Maintenance

Maintenance procedures are described in Chapter 8, "RVO/U-L4 Module BASICS". All safety- and hazard warnings, contained in Chapter 8, "RVO/U-L4 Module BASICS", must be followed. For operation in explosion-hazard zones, all valid provisions for safety, accident prevention and environmental protection must be complied with. Maintenance procedures may only be performed outside the explosion-hazard zone.



DANGER!

Danger to life if maintenance procedures are performed in the explosion-hazard zone

- Maintenance procedures may only be performed outside the explosion-hazard zone

9.1 Return Materials

9.1.1 Return Materials Authorization

For products being returned, regardless of the reason, the currently valid provisions of the returns policy set by MEISTER will apply. Return shipments which do not comply with the returns policy may be refused by MEISTER at the expense of the consignor.

10 Disassembly and disposal

Disassembly and disposal procedures are described in Chapter 9, "RVO/U-L4 Module BASICS". All safety- and hazard warnings, contained in Chapter 9, "RVO/U-L4 Module BASICS", must be followed. For operation in explosion-hazard zones, all valid provisions for safety, accident prevention and environmental protection must be complied with. Disassembly of the device may only be performed outside the explosion-hazard zone.



DANGER!

Danger to life if disassembly procedures are performed in the explosion- hazard zone

- Disassembly may only be performed outside the explosion hazard zone
- Disassembly in an explosion hazard zone may only be performed if there is no risk from an explosive atmosphere

11 Technical data

11.1 Dimension sheet

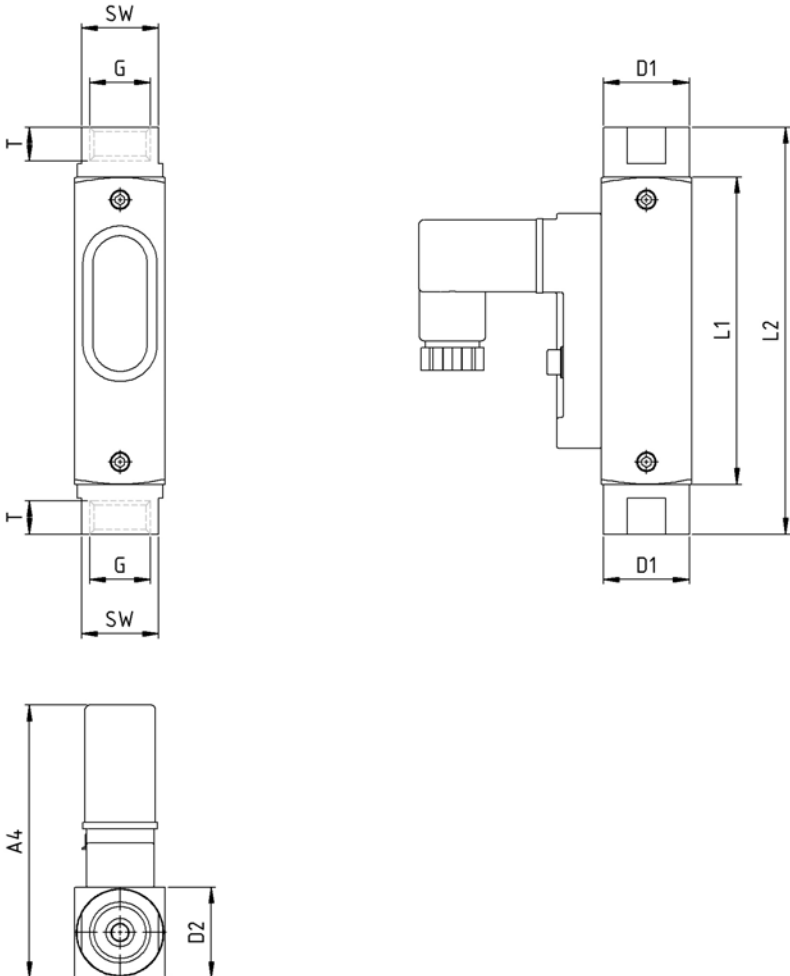

11.2 General specifications

Type	Overall dimensions (mm)					
	G	DN	SW	L1	L2	T
RVO/U-L40001	1/4"	8	17	68	90	10
RVO/U-L40002	1/4"	8	17	68	90	10
RVO/U-L40003	1/4"	8	17	68	90	10
RVO/U-L40005	1/4"	8	17	68	90	10
RVO/U-L40008	1/4"	8	17	68	90	10
RVO/U-L40012	1/4"	8	17	68	90	10
RVO/U-L40014	1/4"	8	17	68	90	10
RVO/U-L40020	1/4"	8	17	68	90	10
RVO/U-L40024	1/4"	8	17	68	90	10
RVO/U-L40035	1/4"	8	17	68	90	10
RVO/U-L40042	1/4"	8	17	68	90	10

Type	Overall dimensions (mm)							
	G	D1	D2	A1	A2	A3	A4	Weight (g)
RVO/U-L40001	1/4"	19	20	-	-	-	60	140
RVO/U-L40002	1/4"	19	20	-	-	-	60	140
RVO/U-L40003	1/4"	19	20	-	-	-	60	140
RVO/U-L40005	1/4"	19	20	-	-	-	60	140
RVO/U-L40008	1/4"	19	20	-	-	-	60	140
RVO/U-L40012	1/4"	19	20	-	-	-	60	140
RVO/U-L40014	1/4"	19	20	-	-	-	60	140
RVO/U-L40020	1/4"	19	20	-	-	-	60	140
RVO/U-L40024	1/4"	19	20	-	-	-	60	140
RVO/U-L40035	1/4"	19	20	-	-	-	60	140
RVO/U-L40042	1/4"	19	20	-	-	-	60	140

* NPT thread on request

** Connecting cable weight, 2m approx. 80g

11.3 Replacement parts

The following replacement parts drawing provides an example of the configuration of an RVO/U-L4 ATEX flow monitor. The actual configuration may vary depending on the model.

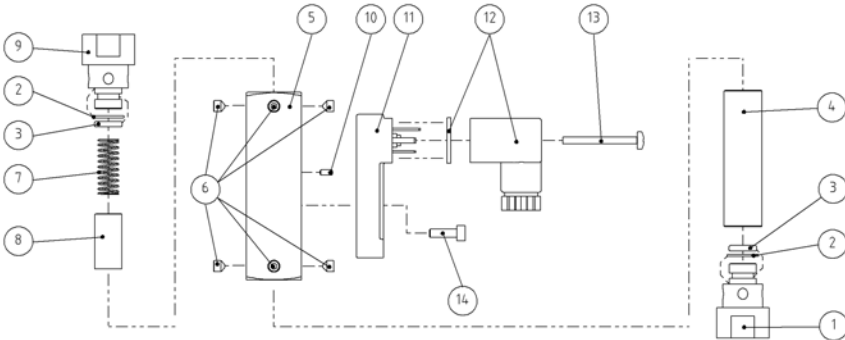

Item	Qty	Description
1	1	Process connection (inlet)
2	2	O-ring (glass buffer)
3	2	O-ring (seal)
4	1	Sight glass
5	1	Device body
6	8	Hex socket screw
7	1	Spring
8	1	Float
9	1	Process connection (outlet)
10	1	Cylinder pin (switch contact)
11	1	Switch contact (ATEX) with male connector

Item	Qty	Description
12	1	Female socket (ATEX) and gasket
13	1	Fixing screw (female socket)
14	1	Set screw (switch contact)

12 Annex

The required tools are specified in Chapter 11.3 "Tools" of the Operating Instructions for "RVO/U-L4 Module BASICS".

In explosion-hazard zones, tools which may cause sparks, are not to be employed. These tools may only be employed when there is no potentially explosive atmosphere present.

The use of steel tools, of any kind, is prohibited in hazard zone 1, if there is a risk of explosion due to substances in explosion hazard group IIC (in accordance with IEC/TR3 60079-20), (for example, acetylene, hydrogen).

13 Index

A

Applicable documents	24
Application	8
Atmosphere	24

C

Categorization	24
mechanical component	16
Contact	6
Contact protection measures	37
Copyright	3
Correct use in explosion-hazard zones	8
Customer service	6

D

Device	
electrical component	24
exterior	14
interior	14
Device category	24
Device group	24
Dimension sheet	43
Disassembly	42
disposal	42

E

Electrical connection	37
Environmental protection regulations	37

G

General	
safety	7
Grounding	37

I

Ignition protection category	24
Initial start-up	37
Installation	37

L

Labeling	
switch contacts	35
Limitation of liability	3
Limiting contacts	24
List of media	19

M

Maintenance	41
-----------------------	----

O

Operating data	
mechanical component	33
switch unit	33
Operation	39

P

Packaging	36
Personnel	12
Precautions	
explosions	11

general	10	Storage	36
Protective systems	13	Symbols used	
R		in the instructions	7
Replacement parts	46	T	
Return Materials Authorization	41	Technical data	
S		general specifications	44
Safety equipment	13	Temperature class internal: T5,	
Safety information		T6, external: T5, T6	18
mechanical component	15	Tools	37, 48
Safety regulations	37	Transport	36
Service	6	Troubleshooting	40
Sight glass		W	
protection	37	Warranty and guarantee provisions	6